

MODELS

Natural Gas	Description	Propane
FPB-20DBSMT-N	20" Round Flat Disc (MT system)	FPB-20DBSMT-P
FPB-20DBSTMSI-N	20" Round Flat Disc (TMSI system)	FPB-20DBSTMSI-P
FPB-20DBSTFS-N	20" Round Flat Disc (TFS system)	FPB-20DBSTFS-P
FPB-26DBSMT-N	26" Round Flat Disc (MT system)	FPB-26DBSMT-P
FPB-26DBSTMSI-N	26" Round Flat Disc (TMSI system)	FPB-26DBSTMSI-P
FPB-26DBSTFS-N	26" Round Flat Disc (TFS system)	FPB-26DBSTFS-P
FPB-29DBSMT-N	29" Round Flat Disc (MT system)	FPB-29DBSMT-P
FPB-29DBSTMSI-N	29" Round Flat Disc (TMSI system)	FPB-29DBSTMSI-P
FPB-29DBSTFS-N	29" Round Flat Disc (TFS system)	FPB-29DBSTFS-P
FPB-34DBSMT-N	34" Round Flat Disc (MT system)	FPB-34DBSMT-P
FPB-34DBSTMSI-N	34" Round Flat Disc (TMSI system)	FPB-34DBSTMSI-P
FPB-34DBSTFS-N	34" Round Flat Disc (TFS system)	FPB-34DBSTFS-P
FPB-44DBSMT-N	44" Round Flat Disc (MT system)	FPB-44DBSMT-P
FPB-44DBSTMSI-N	44" Round Flat Disc (TMSI system)	FPB-44DBSTMSI-P
FPB-44DBSTFS-N	44" Round Flat Disc (TFS system)	FPB-44DBSTFS-P

Outdoor Round Flat Fire Pit Discs

Installation and Operating Instructions

**IF YOU CANNOT READ OR UNDERSTAND THESE INSTALLATION INSTRUCTIONS
DO NOT ATTEMPT TO INSTALL OR OPERATE THIS APPLIANCE**

INSTALLATION PRECAUTION:

This fire pit requires a minimum 18-square inches (per side) of cross ventilation.
Failure to provide proper ventilation can void the warranty.





Warning: For Outdoor Use Only



We recommend that our gas hearth products be installed and serviced by professionals who are certified in the U.S. by the National Fireplace Institute® (NFI) as NFI Gas Specialists.

PLEASE RETAIN THIS MANUAL FOR FUTURE REFERENCE

 <p>DANGER</p>	<p align="center">CARBON MONOXIDE HAZARD</p> <p>This appliance can produce carbon monoxide which has no odor.</p> <p>Using it in an enclosed area can kill you.</p> <p>Never use this appliance in an enclosed space such as a camper, tent, car or home.</p>
	

 **DANGER**

If you smell gas:

1. Shut off gas to the appliance
2. Extinguish any open flame.
3. If odor continues, keep away from the appliance and immediately call your gas supplier or fire department.

 **WARNING**

Do not store or use gasoline or other flammable vapors and liquids in the vicinity of this or other appliances.

Any LP cylinder not connected for use shall not be stored in the vicinity of this or other appliances.

WARNING

Do not leave unattended during use.
Do not use for cooking.
Follow all gas leak procedures in this manual prior to operation.

 **WARNING**

Improper installation, adjustment, alteration, service or maintenance can cause injury or property damage. Read the installation, operating and maintenance instructions thoroughly before installing or servicing this equipment.

WARNING

If the information in these instructions is not followed exactly, a fire or explosion may result causing property damage, personal injury or death.

FOR YOUR SAFETY

Do not store or use gasoline or other flammable vapors and liquids in the vicinity of this or other appliances.

 Fuels used in gas fired appliances, and the products of combustion such as fuels, contain chemicals known to cause cancer, birth defects and/or other reproductive harm. This warning is issued pursuant to the California Health & Safety Code Sec. 25249.1

CALIFORNIA PROPOSITION 65

WARNING

This product can expose you to Chromium, which is known to the state of California to cause cancer and birth defects or other reproductive harm.
(For more information, go to www.p65warnings.ca.gov)

NOTE: This installation instruction covers (3) different ignition systems: Match Light (MT), Thermocouple Manual Safety (TMSI), or Thermocouple Flame Sense (TFS). Look for your specific section in the table of contents.

TABLE OF CONTENTS

Specifications	4-5
Disc Specifications	4
Btu Specifications	5
Preparation for Non-Combustible Structure	6
Hard Piping to Fire Pit	6
Cross Ventilation Requirements	6
High Elevation	6
Gas Pipe Sizing Chart	7
Installation into an Approved Enclosure	8-10
Section A Match Light (MT) Installation	10
Operation & Lighting	11
MT Troubleshooting/Maintenance	12
Expanded MT Model View	13
Section B Thermocouple Manual Safety (TMSI) Installation	14-16
Operation & Lighting	17
TMSI Troubleshooting/Maintenance	18
Expanded TMSI Model View	19
Section C Thermocouple Flame Sense (TFS) Installation	20-23
Operation & Lighting	24
TFS Troubleshooting/Maintenance	25-27
Expanded TFS Model View	28
Replacement Parts	30
Replacement Parts List	31-32
Optional Accessories	33



All media (i.e. lava rock, lava stones, lava boulders and fire glass) has the potential of thermal spalling. This is a process that may occur when media is wet and moisture gets trapped inside of the material due to rapid temperature differences. When this happens the media has the potential to crack or "pop" outside the fireplace.

WE HIGHLY RECOMMEND COVERING ALL FIRE FEATURES WHEN NOT IN USE

The use of a cover can lessen the impact of thermal spalling; however, heavy rains, high humidity and the presence of moisture may still cause the media to pop.

ALWAYS USE CAUTION WHEN USING THE FIRE FEATURE

Extra caution should be taken when lighting a fireplace when heavy rains, high humidity and moisture are present. Light the fireplace; leave the area allowing any moisture in the media to dissipate. We strongly recommend that during this drying out time that you monitor the fire feature from a distance. This drying out period should be no less than 30 minutes. Continue monitoring the flame from distance to ensure that all popping has ceased before fully enjoying the fire.

SPECIFICATIONS

Model: Natural Gas (NG)	Model: Propane Gas (LP)	A Disc Depth	B Pan Diameter	C Min.Install Opening	D Ground Level	E Side Wall	F Combustible Ceiling	G Combustible Floor
FPB-20DBSMT-N	FPB-20DBSMT-P	1/16"	19¾"	20 ½"	18"	19"	69"	18"
FPB-20DBSTMSI-N	FPB-20DBSTMSI-P	1/16"	19¾"	20 ½"	18"	19"	69"	18"
FPB-20DBSTFS-N	FPB-20DBSTFS-P	1/16"	19¾"	20 ½"	18"	19"	69"	18"
FPB-26DBSMT-N	FPB-26DBSMT-P	1/16"	26"	26 ½"	18"	19"	69"	18"
FPB-26DBSTMSI-N	FPB-26DBSTMSI-P	1/16"	26"	26 ½"	18"	19"	69"	18"
FPB-26DBSTFS-N	FPB-26DBSTFS-P	1/16"	26"	26 ½"	18"	19"	69"	18"
FPB-29DBSMT-N	FPB-29DBSMT-P	1/16"	29"	29 ½"	18"	19"	69"	18"
FPB-29DBSTMSI-N	FPB-29DBSTMSI-P	1/16"	29"	29 ½"	18"	19"	69"	18"
FPB-29DBSTFS-N	FPB-29DBSTFS-P	1/16"	29"	29 ½"	18"	19"	69"	18"
FPB-34DBSMT-N	FPB-34DBSMT-P	1/16"	34"	34 ½"	18"	19"	69"	18"
FPB-34DBSTMSI-N	FPB-34DBSTMSI-P	1/16"	34"	34 ½"	18"	19"	69"	18"
FPB-34DBSTFS-N	FPB-34DBSTFS-P	1/16"	34"	34 ½"	18"	19"	69"	18"
FPB-44DBSMT-N	FPB-44DBSMT-P	1/16"	29"	44 ½"	18"	19"	69"	18"
FPB-44DBSTMSI-N	FPB-44DBSTMSI-P	1/16"	34"	44 ½"	18"	19"	69"	18"
FPB-44DBSTFS-N	FPB-44DBSTFS-P	1/16"	44"	44 ½"	18"	19"	69"	18"

Table 1. Disc Specifications

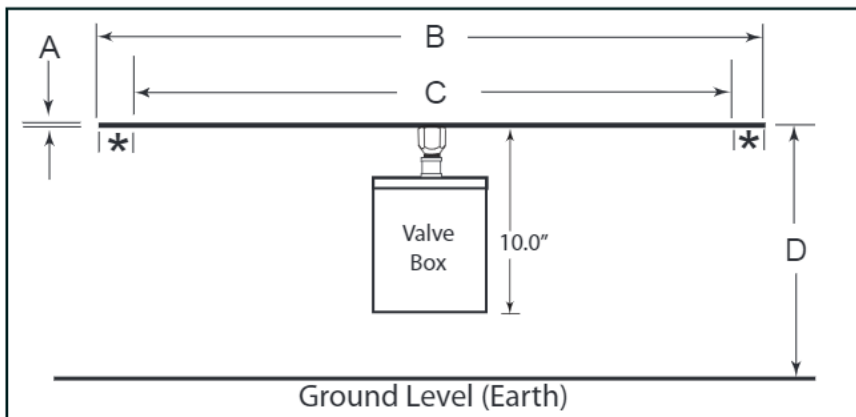

Fig. 1. Flat Disc Dimensions; refer to Table 1.

* (2-inch minimum overlap per side recommended (when applicable) to secure disc with pavers)

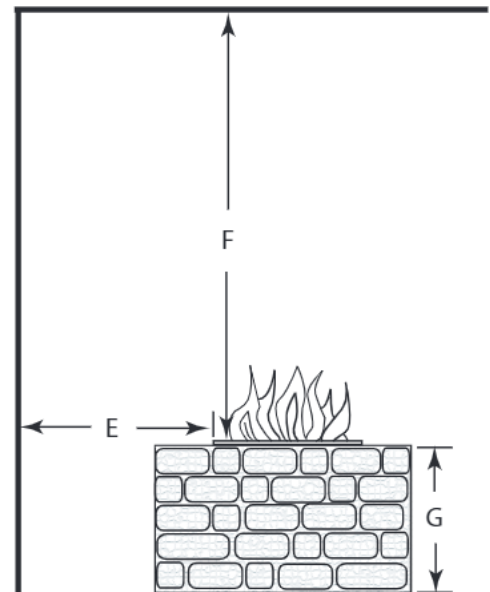

Fig. 2. Clearance to Combustibles
(Not to be used in an enclosed space)

SPECIFICATIONS

<i>Model: Round Disc NG</i>	<i>NG Factory Orifice</i>	<i>NG Btu's High</i>	<i>NG Btu's Low</i>	<i>Model: Round Disc LP</i>	<i>LP Factory Orifice</i>	<i>Btu's High</i>	<i>LP Btu's Low</i>
FPB-20DBSMT-N	#29	65,000	N/A	FPB-20DBSMT-P	#41	65,000	N/A
FPB-20DBSTMSI-N	#29	65,500	N/A	FPB-20DBSTMSI-P	#41	65,000	N/A
FPB-20DBSTFS-N	#19	80,000	45,000	FPB-20DBSTFS-P	#36	79,000	47,400
FPB-26DBSMT-N	#29	65,000	N/A	FPB-26DBSMT-P	#41	65,000	N/A
FPB-26DBSTMSI-N	#29	65,500	N/A	FPB-26DBSTMSI-P	#41	65,000	N/A
FPB-26DBSTFS-N	#7	105,000	51,000	FPB-26DBSTFS-P	#31	100,000	49,500
FPB-29DBSMT-N	#29	65,000	N/A	FPB-29DBSMT-P	#41	65,000	N/A
FPB-29DBSTMSI-N	#29	65,500	N/A	FPB-29DBSTMSI-P	#41	65,000	N/A
FPB-29DBSTFS-N	#7	105,000	51,000	FPB-29DBSTFS-P	#31	100,000	49,500
FPB-34DBSMT-N	#29	65,500	N/A	FPB-34DBSMT-P	#41	65,000	N/A
FPB-34DBSTMSI-N	#29	65,500	N/A	FPB-34DBSTMSI-P	#41	65,000	N/A
FPB-34DBSTFS-N	#7	105,000	51,000	FPB-34DBSTFS-P	#31	100,000	49,500
FPB-44DBSMT-N	#29	65,500	N/A	FPB-44DBSMT-P	#41	65,000	N/A
FPB-44DBSTMSI-N	#29	65,500	N/A	FPB-44DBSTMSI-P	#31	100,000	49,500
FPB-44DBSTFS-N	#7	105,000	51,000	FPB-44DBSTFS-P	#31	100,000	49,500

Table 2. Btu Specifications

Disclaimer: Btu listings are based on 7.0"WC for Natural Gas and 11.0"WC for Liquid Propane (LP) at the burner orifice. Flex line size and proper gas pipe sizing will also affect Btu's. As a result your Btu's may vary slightly from Table 2 specifications.

<i>Pressure</i>	NG	LP
Min. Inlet	5.0" WC	10.5" WC
Max. Inlet	10.5" WC	13.0" WC
Normal Inlet	7.0" WC	11.0" WC
Manifold	5.0" WC	10.5" WC

Table 3. Gas Pressures

NOTE: All disc (MT & TMSI) models come from the factory as Natural gas and can be converted to Propane (LP) gas in the field. TFS models, must be order specifically as Natural gas or Propane; they cannot be converted from one gas to another.

NOTICE

Firegear Outdoors fire pits are constructed and tested to follow the rigid ANSI standards for gas appliances and manufactured safely providing dependable and certified products. If these fire pits are not installed according to the installation manual (i.e. not providing ventilation, not providing proper drainage, installing fire pits below grade or modifying the existing products from a normal installation) Firegear Outdoors cannot be responsible if the product does not operate as designed.

Modifying the fire pit directly out of the carton will void the warranty and nullify the UL listing it was certified for. Before you consider creating your own custom design with a certified product ensure you contact Firegear Outdoors to consult the installation before proceeding. If you move forward and modify a product without consulting, Firegear Outdoors cannot be responsible if the product does not operate as designed.



WARNING: Proper clearances from combustible materials must be maintained from all sides, top and bottom of this appliance. Use the specifications listed on pages 4 and 5 for proper clearance to combustibles.

PREPARING A NON-COMBUSTIBLE STRUCTURE

The fire pit can be installed on a flat, stable surface, away from any combustible materials. Install fire pit on any level, outdoor non-combustible, flat stable surface or a combustible floor according to the clearances specified in this manual.

NOTE: Do not place fire pit directly on grass, dirt, or rocks as this may prevent proper ventilation (Fig. 3). **Ensure proper water drainage is also incorporated into the fire pit enclosure.**

HARD PIPING TO FIRE PIT WITHOUT GAS PROXIMITY

NOTE: Refer to the NFPA54 (National Fuel Gas Code) for proper pipe. See gas pipe sizing chart on page 7.

1. Turn **OFF** gas supply system. **NOTE:** All gas connections (except for brass to brass) require the following. Clean pipe threads using either a wire brush or steel wool. Apply pipe sealant to the fittings before making any connection. **BE CAREFUL!** Ensure all gas connections are snug, but do not over tighten!
2. The primary gas shut-off (not supplied) will require a 1/2" male flared fitting to enable connection of the stainless steel flex gas line supplied with the fire pit.

IMPORTANT

Installation of Natural or LP gas should be done by a qualified installer, service agency or gas supplier. This appliance must be isolated from the gas supply piping system by closing its manual shutoff valve during any pressure testing of the gas supply piping system at test pressures equal to or less than 1/2" psig (3.5kPa)

VENTILATION FOR NON-COMBUSTIBLE ENCLOSURE

Fire pits are subjected to many outdoor elements such as rain, snow, wind, heat or cold. **A minimum of 18 square inches of cross ventilation (2 sides) is required to keep the components in good working order.** Use Fig. 3 as guide to assist to incorporate proper ventilation.

HIGH ELEVATION INSTALLATION

This appliance is listed for elevations from 0- 4500 feet in Canada and the U.S. If elevation exceeds 4500 feet it may be necessary to decrease the input rating by changing the existing burner orifice to a smaller size. Input should be reduced 4% for each 1000 feet beyond the 4500 feet above sea level. Check with your local gas utility for assistance in determining the proper orifice in your location. In some cases the heating value may already be reduced and downsizing the orifice may not be necessary. Refer to NFPA54 Table E.1.1(d) for high altitude orifice sizing.

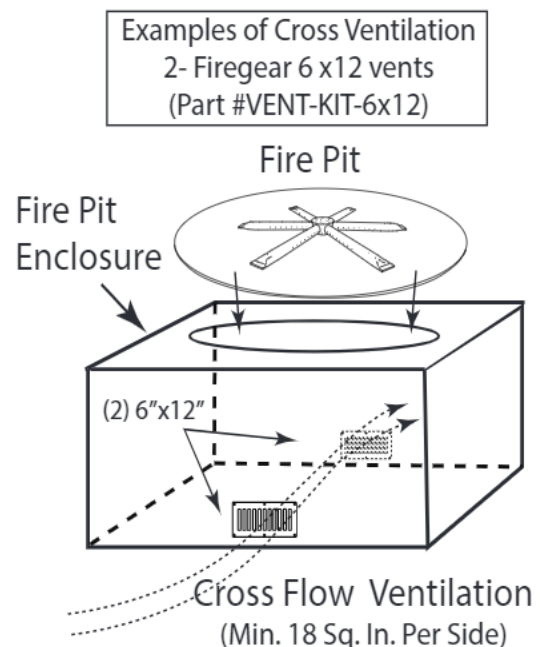

Fig. 3. Cross Ventilation Example

GAS PIPE SIZING CHART

GAS PIPE SIZING

NATURAL GAS : PIPE SIZING CHART

Length of Pipe in Feet	1/2"	3/4"	1"	1 - 1/4"	1 - 1/2"	2"	2 - 2 1/2"	3"	4"
10	108	230	387	793	1237	2259	3640	6434	-
20	75	160	280	569	877	1610	2613	5236	9521
30	61	129	224	471	719	1335	2165	4107	7859
40	52	110	196	401	635	1143	1867	3258	6795
50	46	98	177	364	560	1041	1680	2936	6142
60	42	89	159	336	513	957	1559	2684	5647
70	38	82	149	317	476	896	1447	2492	5250
80	36	76	140	239	443	840	1353	2315	4900
90	33	71	133	275	420	793	1288	2203	4667
100	32	68	126	266	411	775	1246	2128	4518
125	28	60	117	243	369	700	1143	1904	4065
150	25	54	105	215	327	625	1008	1689	3645
175	23	50	93	196	303	583	993	1554	3370
200	22	47	84	182	280	541	877	1437	3160
300	17	37	70	145	224	439	686	1139	2539

- Natural Gas (NG) flow is given in thousands of BTU/hr. = 1 cubic foot of NG gas - 1000 BTU
- Nominal pressure at the burner for Natural Gas is 3.5" of water column. (Typical machine supply 5"-7")
- Pipe length must include additional length for all fittings. Add approximately 5 feet of pipe per fitting.
- Natural Gas Example: A machine with a burner that requires 440,000 BTU would need a 1 -1/4" pipe for a 20" long run.

LIQUID PROPANE : PIPE SIZING CHART

Length of Pipe in Feet	1/2"	3/4"	1"	1 - 1/4"	1 - 1/2"	2"	2 - 2 1/2"	3"	4"
10	275	567	1071	2205	3307	6221	10140	17990	35710
20	189	393	732	1496	2299	4331	7046	12510	25520
30	152	315	590	1212	1858	3465	5695	10110	20620
40	129	267	504	1039	1559	2992	4778	8481	17300
50	114	237	448	913	1417	2646	4343	7708	15730
60	103	217	409	834	1275	2394	3908	6936	14150
70	89	185	346	724	1086	2047	3329	5908	12050
80	78	162	307	630	976	1811	2991	5309	10830
90	69	146	275	567	866	1606	2654	4711	9613
100	63	132	252	511	787	1496	2412	4281	8736
125	54	112	209	439	665	1282	2083	3618	7382
150	48	100	185	390	590	1138	1808	3210	6549
175	43	90	168	353	534	1030	1637	2905	5927
200	40	83	155	325	491	947	1505	2671	5450
300	37	77	144	303	458	887	1404	2492	5084

- Liquid Propane (LP) Gas flow is given in thousands of BTU/hr. = 1 cubic foot of LP gas - 2500 BTU.
- This chart refers to low pressure LP, after regulation. Standard nominal pressure at the burner for Liquid Propane Gas is 11" of water column.
- Pipe length must include additional length for all fittings. Add approximately 5 feet of pipe per fitting.
- LP Example: A machine with a burner that requires 440,000 BTU would need a 1" pipe for a 20' long run.

NOTE: The sizing charts above list the specific pipe sizes required for the amount of BTU's for a new gas line installations. If you are using an existing gas line you must take into consideration the existing gas line capacities to ensure you will have proper pressure. **This chart is for reference only, we recommend you consult with a Licensed Plumber/Gas Fitter or NFPA54 (National Fuel Gas Code - current edition) for more details.**

Table 4 Gas pipe sizing chart



Section A

Match Light (MT) Installation



INSTALLATION OF FIRE PIT INTO AN APPROVED ENCLOSURE

REQUIREMENTS

1. Only non-combustible materials should come in direct contact with any part of the fire pit. Underneath area should be non-combustible or a flat level combustible surface according to the clearances specified in this manual..
2. Refer to the NFPA54 (National Fuel Gas Code) for proper pipe sizing. See gas pipe sizing chart on page 7.
3. Determine the size of the round fire pit you are preparing to install (Refer to page 4).
4. You must provide a round opening cut-out opening to place the flat disc onto the non-combustible enclosure. Do not exceed the maximum opening from Table 1, dimension B located on page 4.
5. Follow the local code requirements for the gas type being used. This fire pit should be installed in accordance with local codes and ordinances or in the absence of local codes, with the latest National Fuel Gas Code, ANSI Z223.1 NFPA54 or CSA B149.1, Natural and Propane Installation Code in Canada.
6. Fire pits create high temperatures, it is very important to have any combustibles at a safe distance. Refer to page 4.
7. **CAUTION: A minimum of 18 square inches of cross ventilation (per side) is required to keep the inside of the enclosure dry. We recommend installation of a VENT-KIT-6x12. See accessory section.**
8. These products are designed for outdoor use only. Not approved for any indoor use.
9. This fire pit is designed to have lava rock completely covering the spur burner, so that the burner is not visible. Do not cover more than 1" above the top of the burner. When purchasing lava rock use 1" to 2" diameter as a base to cover the flat disc.
10. Gas lines and fittings must be installed in to the non-combustible structure. All gas connections must be leak tested before installation of the fire pit. Soapy water leak detection is required before regular use of the fire pit.
11. Do not use material that will absorb moisture over time and will not release this moisture quickly. Moisture can boil in this material and can rapidly break apart and cause damage or personal injury.
12. Never leave any other combustible material on top of the fire pit. This could cause unsafe operation of this system and damage to the component that will not be covered under our warranty.
13. **Ensure proper water drainage is also incorporated into the fire pit enclosure.**

Flat disc's are typically used with landscape blocks. The illustrations below show examples of possible installations.

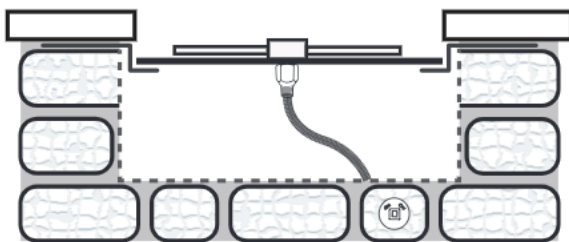

Fig.4 Shows disc secured under stone caps.

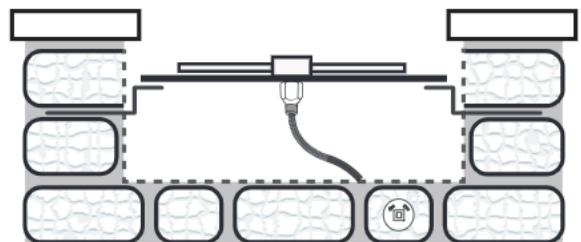

Fig. 5 Shows disc secured between layer of block.

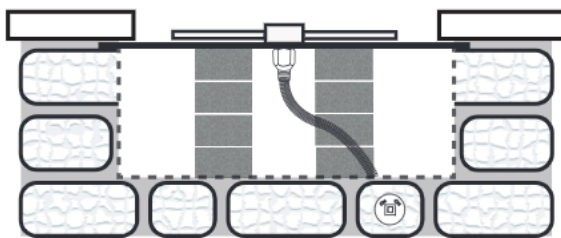

Fig. 6 Shows blocks supporting center of disc.

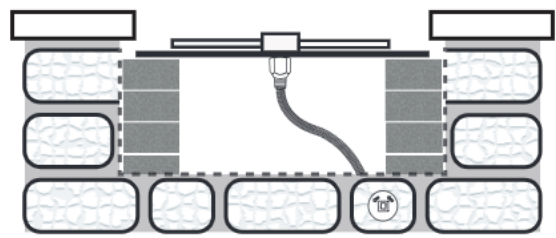
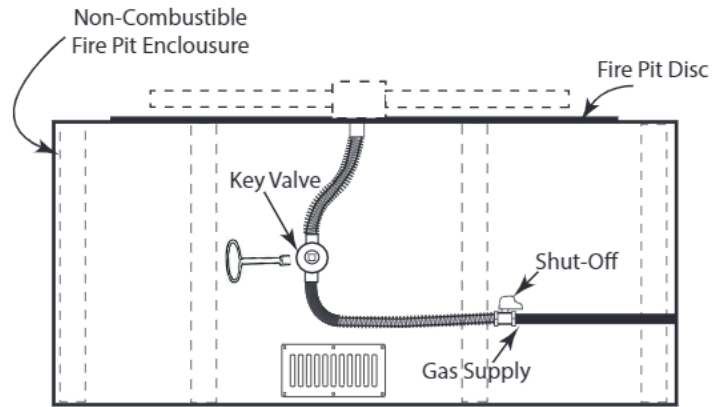
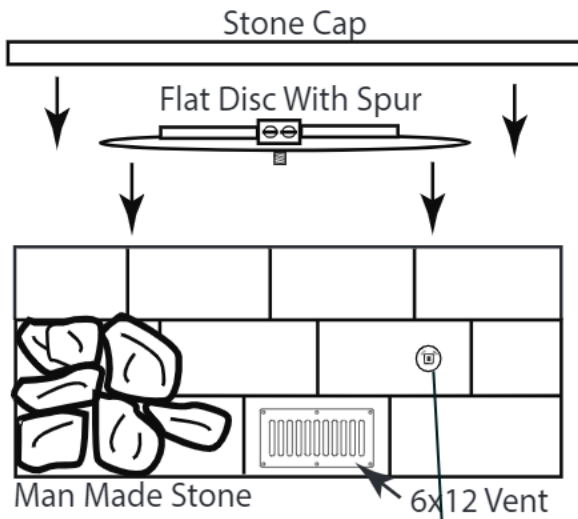

Fig. 7 Shows blocks supporting an oversized opening.

Cement Block Illustration



NOTE: Key valve and flexible gas lines are supplied. Gas shut-off is not supplied.

INSTALLING KEY VALVE

The key valve contents: 1- key valve, 1- key and 1- flange. The valve requires a 1" round clearance hole in the non-combustible enclosure wall. See the instructions supplied with the key valve for more specific details. **Note:** Be sure to leak test all fitting before operation. Figures 8 shows an example of a typical installation.

Key Valve Side View Detail

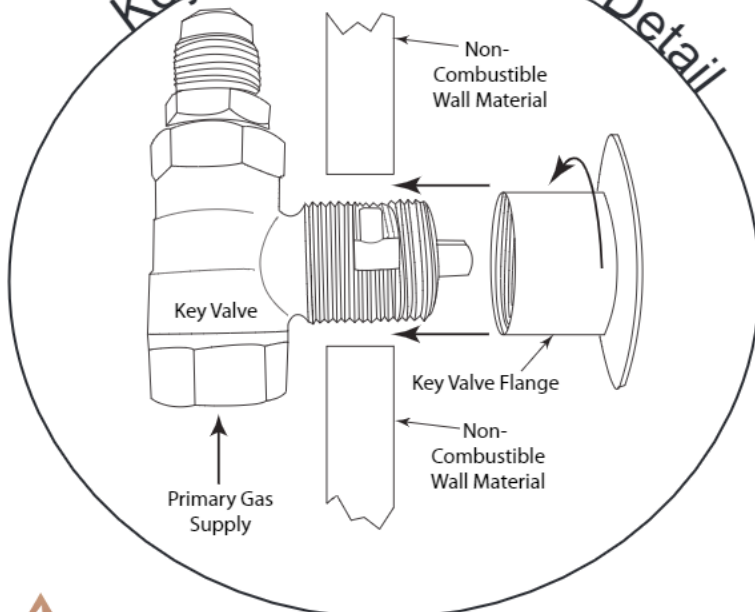

Note: A 1 1/4" x 2" black iron or galvanized coupler/nipple (not supplied) can be used as a spacer between the manual valve and the valve flange to add additional support to hold the manual key valve in place.

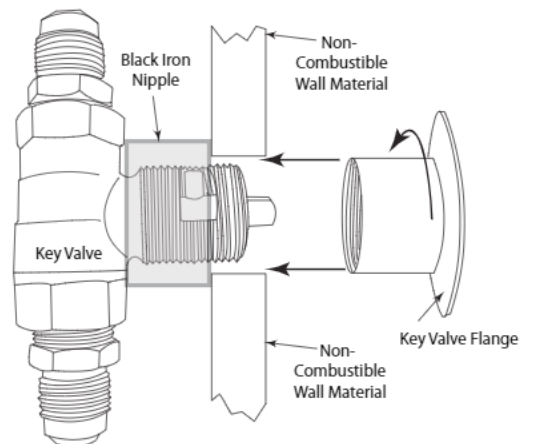

Fig. 8 Typical installations.

OPERATION

CAUTION: Children and adults should be alerted to the hazards on high surface temperatures and should stay away to avoid burns or clothing ignition. Young children should be carefully supervised when they are in the area of the appliance.

WARNING: Do not use this appliance if any part has been under water. Immediately call a qualified service technician to inspect the appliance and to replace any part of control system and any gas control, which has been under water.

SAFETY WARNINGS

1. Never leave the fire pit unattended during operation.
2. Clothing or other flammable materials should not be placed on or near the appliance.
3. Any guard or other protective device removed for servicing the appliance must be replaced prior to operating the appliance.
4. Installation and repair should be done by a qualified service person. The appliance should be inspected before use and at least annually by a qualified service person. More frequent cleaning may be required as necessary. It is imperative the control compartment, burners and circulating air passageways of the appliance be kept clean.
5. Inspect the fuel supply connection before each use of the appliance.
6. Temporary storage of this appliance indoors is permissible only if it has been disconnected from its fuel supply (Natural or L.P. gas line).

WARNING

1. This appliance is hot when operated and can cause severe burns if contacted.
2. Do not burn any solid fuels in this appliance.

LIGHTING INSTRUCTIONS

READ ALL WARNING AND SAFETY INFORMATION ABOVE BEFORE ATTEMPTING TO LIGHT FIRE PIT

CAUTION: Ensure you have leak tested the fire pit before operating.

TURNING ON FIRE PIT

1. Insert key into shut-off valve and secure into square end (see Figs 9 & 10).
2. Light a long match or butane lighter and hold it near the burner (see Fig. 11).
3. Turn the key counter-clockwise in gas valve (until it stops) to allow gas to flow and simultaneously apply the long burning match or Butane lighter as close to the end burner as possible to light the fire pit.
4. Gas should ignite within 10 seconds or less. If fire pit does not light within 10 seconds turn key clockwise to turn **OFF** the gas supply. Ensure there is not too much media on top of the burner that might inhibit gas flow and try again in 5 minutes.

TURNING OFF FIRE PIT

1. Insert key into shut-off valve and secure into square end.
2. Turn key clockwise until it stops.
3. After cooling off install cover.

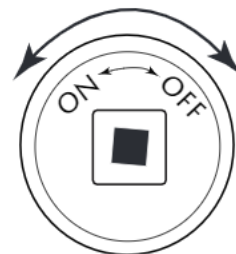

Fig. 9. Key Valve Face

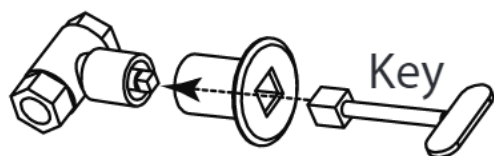

Fig. 10 Inserting Key into Valve

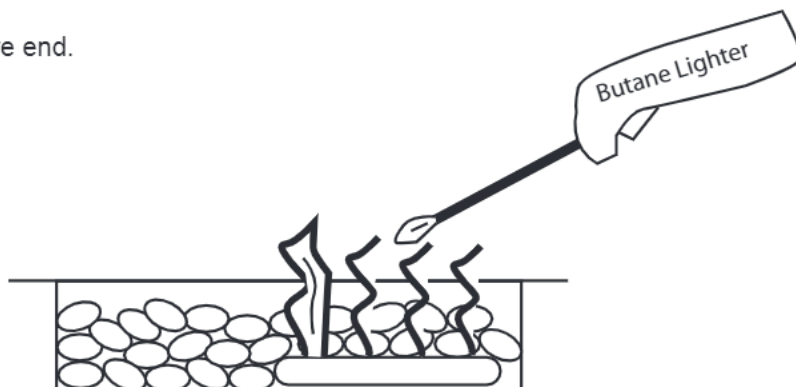

Fig. 11 Lighting fire pit with lighter

FIRE PIT MAINTENANCE

1. The fire pit should be inspected and cleaned before initial use at least annually by a qualified field service person.
2. Any component that is found faulty must be replaced with an approved component.
3. Any tampering or modifying with the fire pit is dangerous and voids all warranties.
4. During winter months in cold climates and various seasons operation the fire pit may be affected by weather conditions. It is recommended to use a cover/lid for your fire pit to protect it from humid/rainy weather conditions when not in use. Heavy rains/downpours could affect the fire pit operation if not covered; if this occurs ensure you allow the fire pit time to dry out before attempting to operate. **NOTE:** If a combustible type cover is used over the fire pit when not in use be sure to remove it before operation to prevent a severe safety hazard.
5. Over time stainless steel parts can discolor when heated, usually a golden or brown hue. This discoloration is normal and does not affect the performance of the appliance.

MT TROUBLE SHOOTING

SECTION A - MATCH LIGHT (MT) INSTALLATION

<u>Symptom</u>	<u>Remedy</u>
Fire pit won't light	<ol style="list-style-type: none"> 1. Bleed gas line. 2. Ensure all gas supply lines are turned ON. 3. Ensure there is not too much media overtop of burner; it can inhibit gas from flowing. 4. Check gas pressure.
Low flame	<ol style="list-style-type: none"> 1. Ensure the base media is at least 1 to 2-inches in diameter and top media is no more than 1-inch over top of burner. 2. Ensure all shut-off valves and key valve is fully open. See page 11. 3. Check for spider webs inside the orifice. 4. Check gas pressure.
Water in my fire pit	<ol style="list-style-type: none"> 1. Excess dust/sand material from media may be blocking the weep holes to relieve water. Remove all media and unplug weep holes. Clean or install new media free of dust and dirt. 2. Ensure fire pit enclosure has proper drainage for water and proper ventilation to dry out. 3. Recommend to purchase a cover/lid to keep excessive water out of the fire pit.
Whistling Noises	<ol style="list-style-type: none"> 1. Check media to ensure it is not too tightly packed around the burner tube. 2. Ensure a non-whistling flex connector is being used.

Expanded View of Match Throw (MT) Fire Pits

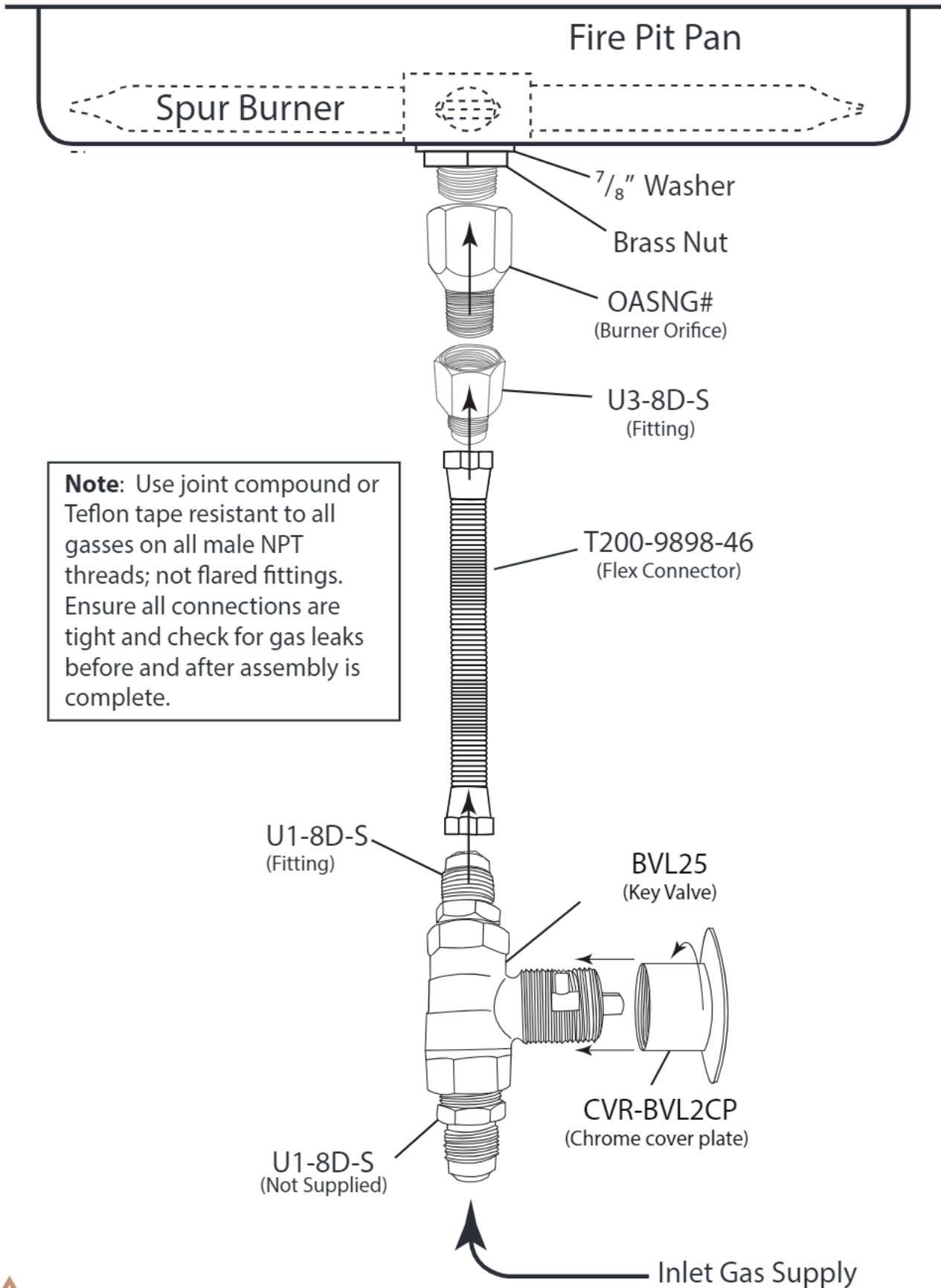

Section B

Thermocouple Manual Safety (TMSI) Installation

INSTALLATION OF FIRE PIT INTO AN APPROVED ENCLOSURE

REQUIREMENTS

1. Only non-combustible materials should come in direct contact with any part of the fire pit. Underneath area should be non-combustible or a flat level combustible surface according to the clearances specified in this manual.
2. Refer to the NFPA54 (National Fuel Gas Code) for proper pipe sizing. See gas pipe sizing chart on page 7.
3. Determine the size of the round fire pit you are preparing to install (Refer to page 4).
4. You must provide a round opening out to place the flat disc onto the non-combustible enclosure. Do not exceed the maximum opening from Table 1, dimension B located on page 4.
5. Follow the local code requirements for the gas type being used. This fire pit should be installed in accordance with local codes and ordinances or in the absence of local codes, with the latest National Fuel Gas Code, ANSI Z223.1 NFPA54 or CSA B149.1, Natural and Propane Installation Code in Canada.
6. Fire pits create high temperatures, it is very important to have any combustibles at a safe distance. Refer to page 4.
7. **CAUTION: A minimum of 18 square inches of cross ventilation (per side) is required to keep enclosure dry. We recommend installation of a VENT-KIT-6x12. See accessory section.**
8. These products are designed for outdoor use only. Not approved for any indoor use.
9. This fire pit is designed to have lava rock completely covering the spur burner, so that the burner is not visible. Do not cover more than 1" above the top of the burner. When purchasing lava rock use 1" to 2" diameter as a base to fill the flat disc.
10. **Gas lines and fittings must be installed in to the non-combustible structure. All gas connections must be leak tested before installation of the fire pit. Soapy water leak detection is required before regular use of fire pit.**
11. Do not use material that will absorb moisture over time and will not release this moisture quickly. Moisture can boil in this material and can rapidly break apart and cause damage or personal injury.
12. Never leave any other combustible material on top of the fire pit. This could cause unsafe operation of this system and damage to the component that will not be covered under our warranty.
13. **Ensure proper water drainage is also incorporated into the fire pit enclosure.**

Flat disc pans are typically used with landscape blocks. The illustrations below show examples of possible installations.

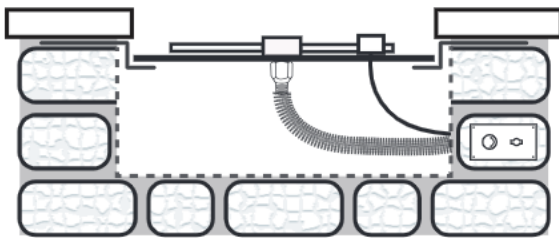

Fig. 12 Shows disc secured under stone caps.

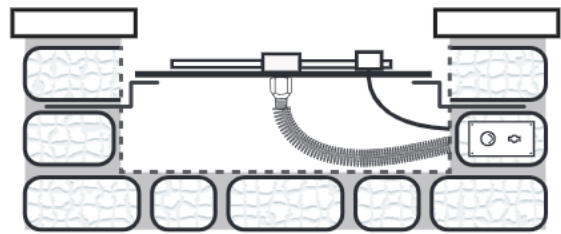

Fig.13 Shows disc secured between layer of block.

NOTE: Methods of supporting the center of the disc underneath or supporting an oversized opening are shown on page 6 in figures 6 & 7.

INSTALLING GAS VALVE

The gas valve is secured into the mounting plate with a nut. Fig. 12 shows an example of a typical installation.

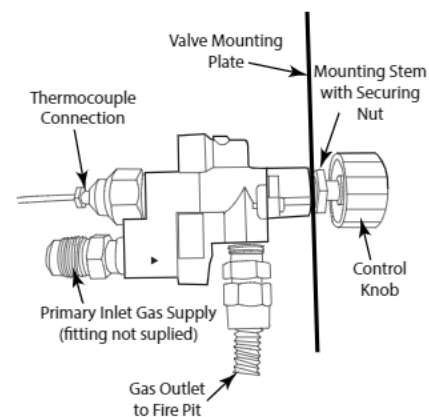
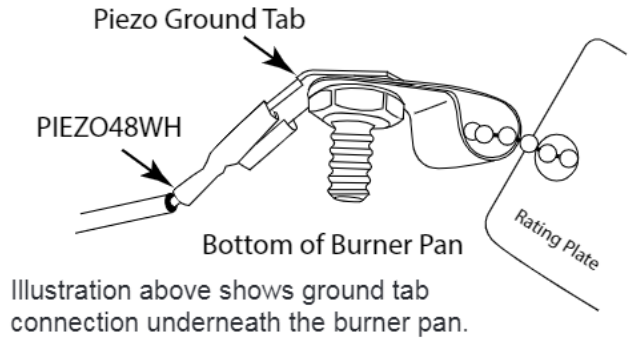
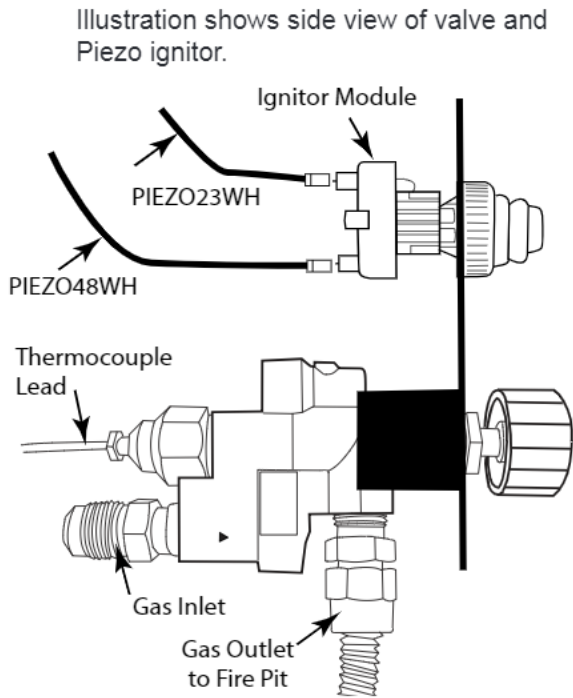

Fig. 14 Gas valve components.



Remove red button cap and install battery into Piezo ignitor module.

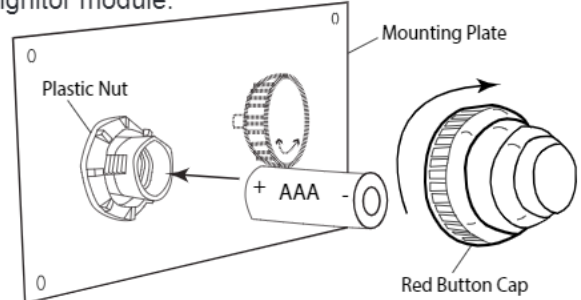

Fig. 15 TMSI typical installation.

Note: See optional mounting method of TMSI face plate on back of this manual.

IGNITOR ALIGNMENT

It is important check that the ignitor probes be properly aligned over-top of the burner port holes and did not move during shipping. Use the Fig.16 as a guide. Before lighting remove the screen cover of the ignition hood to burner and ensure the thermocouple is directly over-top of a burner port hole. The sparking probes and the thermocouple must be in the path of a flame to ignite the gas for proper ignition of the flame. Replace the screen cover and follow the operating instructions.

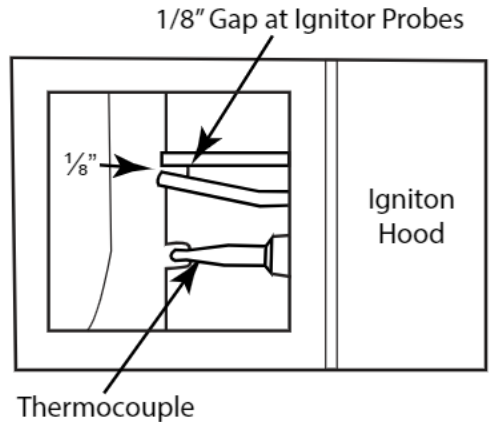

Fig. 16 Proper alignment of thermocouple.

INSTALLATION OF LAVA ROCK/MEDIA INTO BURNER PAN

Install lava rock into the burner pan. Ensure the lava rock is a 1-inch diameter for proper operation. **Note:** Do not pour Lava Rock directly from bag. It should be placed naturally and NOT packed in tight. Loose fitting is important to ensure robust flames. Be sure rocks are free of any excessive dust. This prevents the burner pan weep holes from being plugged and holding water.

IMPORTANT: Do not place rock over top or under the screen cover. The screen must be free of any debris to ensure proper lighting of burner and good flame sense (See Fig. 17).

Cover the burner completely with media but do not make the depth greater than 1-inch overtop of the burner portholes.

Do NOT cover the screen mesh with any rock or glass. It must be free an any debris to operate properly.

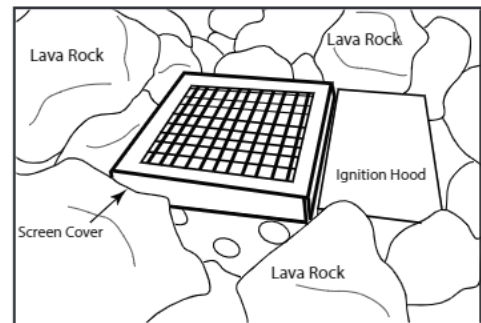

Fig. 17 Keep screen cover exposed

OPERATION

CAUTION: Children and adults should be alerted to the hazards on high surface temperatures and should stay away to avoid burns or clothing ignition. Young children should be carefully supervised when they are in the area of the appliance.

WARNING: Do not use this appliance if any part has been under water. Immediately call a qualified service technician to inspect the appliance and to replace any part of control system and any gas control, which has been under water.

SAFETY WARNINGS

1. Never leave the fire pit unattended during operation.
2. Clothing or other flammable materials should not be placed on or near the appliance.
3. Any guard or other protective device removed for servicing the appliance must be replaced prior to operating the appliance.
4. Installation and repair should be done by a qualified service person. The appliance should be inspected before use and at least annually by a qualified service person. More frequent cleaning may be required as necessary. It is imperative the control compartment, burners and circulating air passageways of the appliance be kept clean.
5. Inspect the fuel supply connection before each use of the appliance.
6. Temporary storage of this appliance indoors is permissible only if it has been disconnected from its fuel supply (Natural or LP gas line).

WARNING

1. This appliance is hot when operated and can cause severe burns if contacted.
2. Do not burn any solid fuels in this appliance.

READ ALL LIGHTING INSTRUCTIONS BEFORE ATTEMPTING TO LIGHT FIRE PIT

CAUTION: ENSURE YOU HAVE LEAK TESTED THE FIRE PIT BEFORE OPERATING.

WARNING: Do not stand over fire pit during ignition or operation due to high surface temperatures.

LIGHTING INSTRUCTIONS

TURNING ON FIRE PIT

1. Depress and hold the red Piezo ignitor button and ensure sparking is occurring at the probes inside ignition hood.
2. Rotate control knob on gas valve counter clockwise to the ON position.
3. Depress control knob inward to light the burner.
4. After the fire pit lights release the Piezo button but continue to depress the control knob for at least 30 seconds then release knob. If fire pit does not light within 30 seconds, release control knob, turn knob clockwise to turn OFF and wait 5 minutes before trying again. Turn gas supply OFF to check probe spacing and Piezo battery if fire pit does not light.
5. Repeat steps 1-4.

TURNING OFF FIRE PIT

1. Slight push inward on control knob and turn clock wise until it stops. Fire pit will turn OFF.
2. After cooling off install cover.



Red Piezo Button

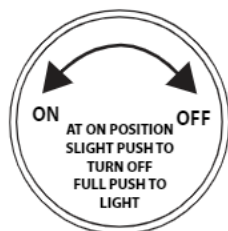

Control Knob

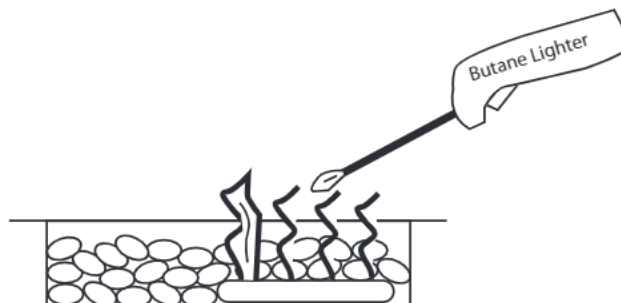

Fig. 19 Lighting with Butane lighter

Fig. 18. Control knob and Piezo button

FIRE PIT MAINTENANCE

1. The fire pit should be inspected and cleaned before initial use at least annually by a qualified field service person.
2. Any component that is found faulty must be replaced with an approved component.
3. Any tampering or modifying with the fire pit is dangerous and voids all warranties.
4. During winter months in cold climates and various seasons operation the fire pit may be affected by weather conditions. It is recommended to use a cover/lid overtop of your fire pit to protect it from humid/rainy weather conditions when not in use. Heavy rains/downpours could affect the fire pit operation if not covered; if this occurs ensure you allow the fire pit time to dry out before attempting to operate. **NOTE:** If a combustible type cover is used over the fire pit when not in use be sure to remove it before operation to prevent a severe safety hazard.
5. Carbon (soot) may build up on the surface of logs (if installed) during heavy use. Sooting may also occur periodically on the screen of the ignitor hood. To clean, brush off with a dry bristle brush or cloth. Keep soot away from clothing or furniture.
6. Over time stainless steel parts can discolor when heated, usually a golden or brown hue. This discoloration is normal and does not affect the performance of the appliance.

TMSI TROUBLE SHOOTING

<u>Symptom</u>	<u>Remedy</u>
Fire pit won't light	<ol style="list-style-type: none">1. Bleed gas line.3. Ensure all gas supply lines are turned ON.4. Ensure there is not too much media overtop of burner; it can inhibit gas from flowing.
Low Flame	<ol style="list-style-type: none">1. Ensure the base media is at least 1-inch in diameter and top media is no more than 1-inch over top of burner.2. Ensure all shut-off valves and valve is fully open. .3. Check for spider webs inside burner orifice.
Water in my fire pit	<ol style="list-style-type: none">1. Excess dust/sand material from media may be blocking the weep holes to relieve water. Remove all media and unplug weep holes. Clean or install new media free of dust and dirt.2. Ensure fire pit enclosure has proper drainage for water and proper ventilation to dry out.3. Recommend to purchase a cover/lid to keep excessive water out of the fire pit.
Whistling Noises	<ol style="list-style-type: none">1. Check media to ensure it is not too tightly packed around the burner tube.2. Ensure a non-whistling flex connector is being used.
Fire pit won't stay lit	<ol style="list-style-type: none">1. Check alignment of thermocouple over rainshield on page 16, Fig.162. Ensure thermocouple is not screwed too tight into gas valve. It should be finger tight plus a quarter turn with a wrench.3. Ensure thermocouple is clean and free of any debris. Excessive soot can be an issue.

Expanded View of Thermocouple Manual (TMSI) Safety Fire Pit

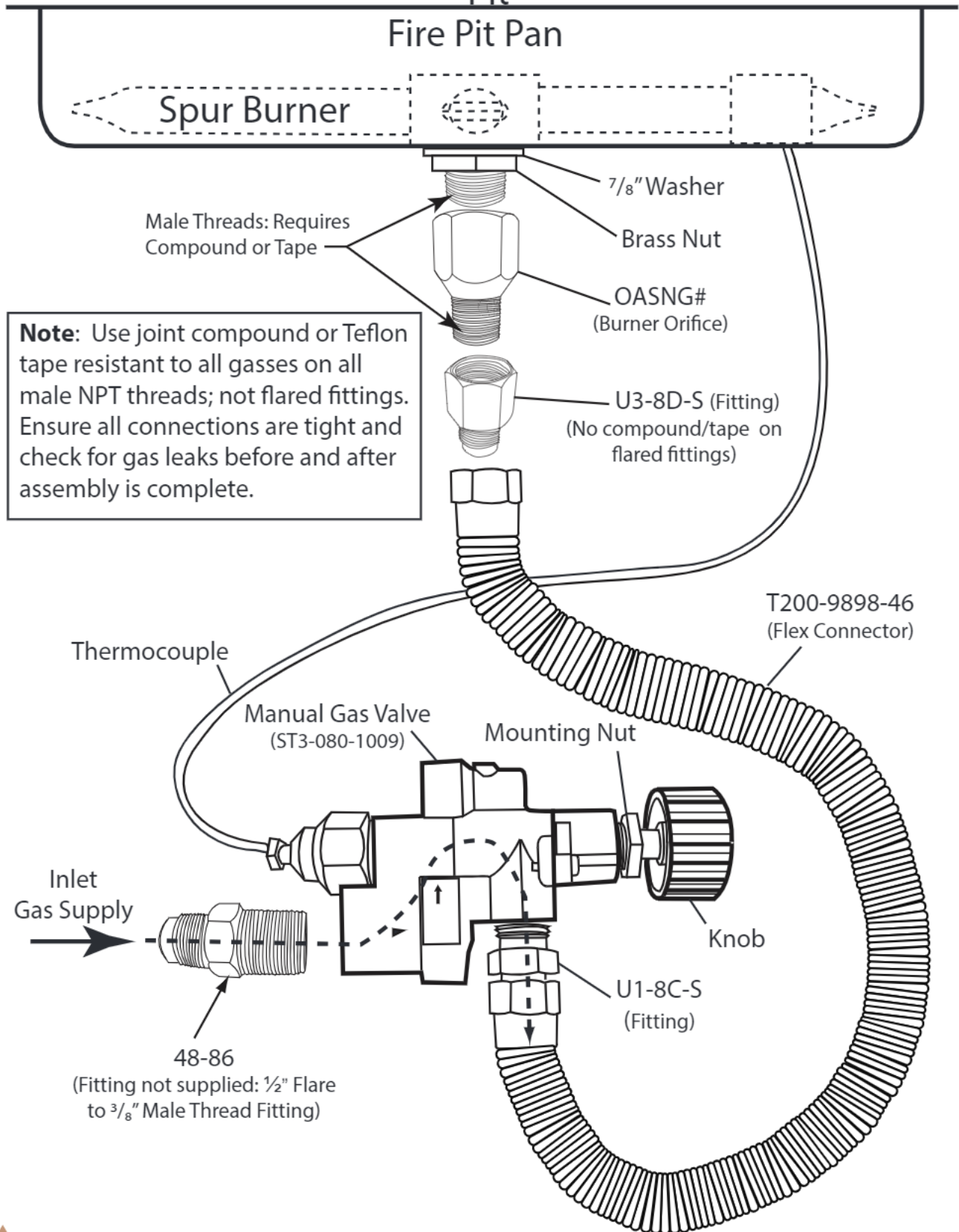

Note: Use joint compound or Teflon tape resistant to all gasses on all male NPT threads; not flared fittings. Ensure all connections are tight and check for gas leaks before and after assembly is complete.



Section C

Thermocouple Flame Sense (TFS) Installation

INSTALLATION OF FIRE PIT INTO AN APPROVED ENCLOSURE

REQUIREMENTS

1. Only non-combustible materials should come in direct contact with any part of the fire pit. Underneath area should be non-combustible or a flat level combustible surface according to the clearances specified in this manual.
2. Refer to the NFPA54 (National Fuel Gas Code) for proper pipe sizing. See gas pipe sizing chart on page 7.
3. Determine the size of the round fire pit you are preparing to install (Refer to page 4).
4. You must provide a round opening out to place the flat disc onto the non-combustible enclosure. Do not exceed the maximum opening from Table 1, dimension B located on page 4.
5. Follow the local code requirements for the gas type being used. This fire pit should be installed in accordance with local codes and ordinances or in the absence of local codes, with the latest National Fuel Gas Code, ANSI Z223.1 NFPA54 or CSA B149.1, Natural and Propane Installation Code in Canada.
6. Fire pits create high temperatures, it is very important to have any combustibles at a safe distance. Refer to page 4.
7. Normal operation of the fire pit is with a battery pack that is supplied with your system (Fig 18). The battery box has 12-feet of black sleeved wire that is to be passed through the junction box provided. This wire should not be cut or spliced and the junction box can be placed in the facing of the vertical finish of the fire pit, if you place the wire under ground you should install those wires into an approved protective conduit/sleeve material.
8. Fire pit should never be left unattended while in operation. It should always be a safe distance from all trees and combustible landscape materials.
10. Construction of the finished fire pit should be stable and solid. From the bottom of the control box that houses the gas valve and module, it should be according to specifications on Table #1. **NOTE: Proper drainage is critical to ensure that water does not damage gas valve and components.** Never install fire pit below grade.
11. **CAUTION: The fire pit enclosure *MUST* have a minimum ventilation of 18 square inches on each side to keep the inside of the finished enclosure dry. We recommend installation of a VENT-KIT-6x12. See accessory section.**
12. The insulation square pad provided with the fire pit is to be placed foil up toward the bottom of pan on top of the valve box.
13. Never fill the cavity under and around the valve box with any material, this is a provided air space necessary for ventilation.
14. These products are designed for outdoor use only. Not approved for any indoor use.
15. This fire pit is designed to have decorative rock, lava rock/media covering the burner, so the burner is not visible. Optional concrete logs can be added to consumers taste. Decorative rock is not provided. When purchasing decorative rock use minimum of 1 to 2-inch diameter rock as a base to fill the burner pan. **DO NOT COVER THE IGNITION HOOD WITH ANY ROCK OR MEDIA.**
16. Gas lines and fittings must be installed in to the non-combustible structure. All gas connections must be leak tested before installation of the fire pit. Soapy water leak detection is required before regular use of the fire pit.
17. Do not use material that will absorb moisture over time and will not release this moisture quickly. Moisture can boil in this material and can rapidly break apart and cause damage or personal injury.
18. Never leave any other combustible material on top of the fire pit. This could cause unsafe operation of this system and damage to the component that will not be covered under the warranty.

Flat disc pans are typically uses with landscape blocks. The illustrations below show examples of possible installations.

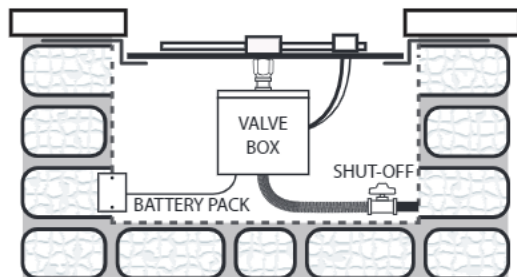

Fig. 20 Typical installation.

NOTE: Methods of supporting the center of the disc underneath or supporting an oversized opening are shown on page 9 in Figs. 6 & 7.

NOTE: Gas valve, flexible gas lines and TFS components are supplied. Gas shut-off is not supplied. Battery pack can be installed within the 12-foot wire length. If exposed to the elements a weather proof box is recommended.

FINAL PREPARATIONS

INSTALLATION OF BATTERY PACK

It is important to locate the battery pack where it is easy to access for battery replacement and service. The best location is on the outside wall of the fire pit enclosure. A plastic junction box is provided for the installation of the battery pack and a weather-proof cover to protect it from the outside elements.

1. Install (4) AA batteries in to the battery pack by sliding the cover off as shown in Fig. 21. Double check to ensure the switch on front of the battery pack is in the latching solenoid position. Install the battery pack cover plate by snapping it into place on the back side of the white cover plate as shown in Fig. 22. **Note:** Be sure the batteries are installed positive-to-positive and negative-to-negative. If one battery is installed backwards the system will not operate.
2. Install the junction box and secure into position. **Note:** Junction box should be flush with the finish materials to ensure weatherproof cover/lid has room (clearance) to open. See Fig. 23.
3. The fire pit has 12-feet of wiring outside of the valve box underneath the burner pan. One end of the wiring has a 4-pin connector. The others are (2) two individual wires (one black and one red) with $\frac{1}{4}$ " female connectors.
4. Feed the wire ends into the junction box and out the front (approximately 4-6 inches) to connect to battery pack (See wiring diagram on page 27, Fig. 29 and Fig. 23).
5. Open the lid of the weatherproof cover and install the white cover plate with battery pack attached into the weather proof cover and rubber gasket.
6. Connect the wires from the junction box to the battery pack. Plug the white 4-pin connector into back of the battery pack and connect the two $\frac{1}{4}$ " female spade wires matching color, red-to-red and black-to-black. Leave enough "play" in the wires to allow the weatherproof cover/lid and be screwed to the junction box.
7. Secure the weatherproof cover/lid to the two outside holes at the top and bottom of the junction box.
8. Secure the white cover plate and battery pack to the center holes at the top and bottom of the junction box.
9. After the fire pit is installed into the enclosure, the burner and control system should be tested before the media (lava rock) is installed. **Note:** Flame height will be very low until media is placed into the burner pan covering the burner.

Requires 4-AA 1.5V
alkaline batteries

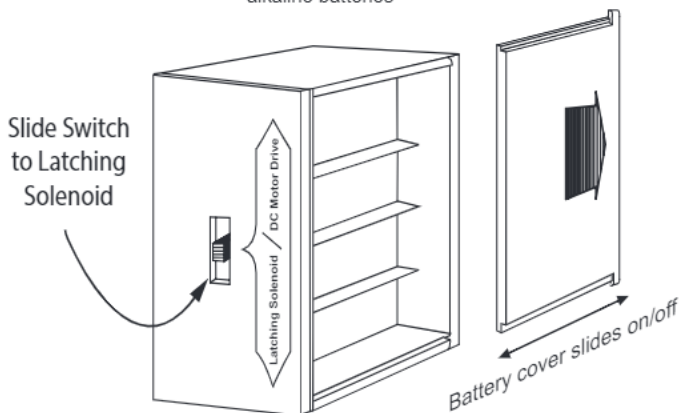

Fig. 21. Slide switch on latching solenoid

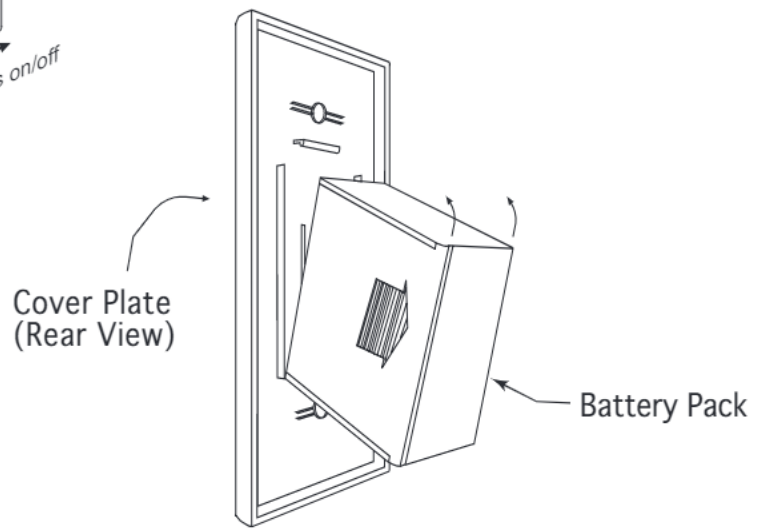

Fig. 22 Cover plate installation

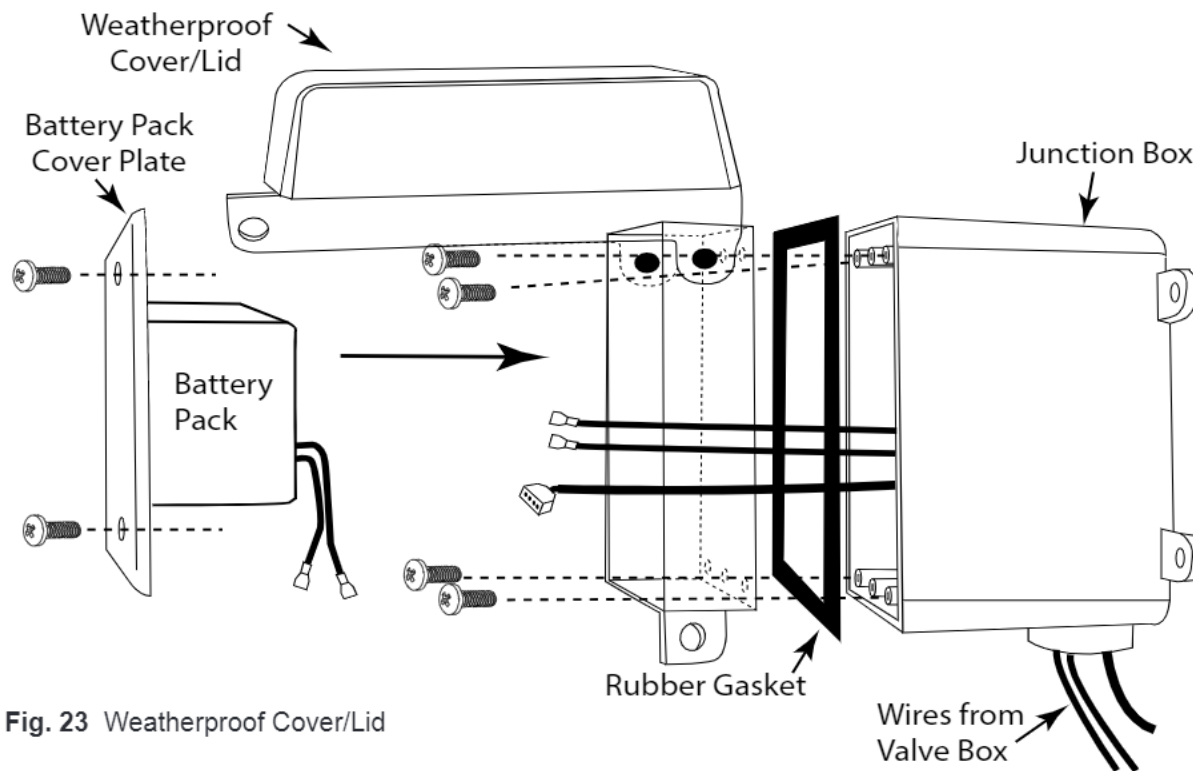

Fig. 23 Weatherproof Cover/Lid

INSTALLATION OF BATTERY INTO TRANSMITTER

You have one handheld transmitter and you will need to install the included (12-volt battery) into the transmitter. On the backside of the transmitter, push the cover away from the case. Place the battery into the compartment matching positive-to-positive and negative-to-negative. To ensure the battery is properly installed push any button on the transmitter and you will see a red LED light at the top of the transmitter glow. The red LED light will only be lit when a button is pushed.

IGNITOR ALIGNMENT

It is important check that the ignitor probes be properly aligned overtop of the burner port holes and did not move during shipping. Use the Fig. 24 as a guide. Before lighting remove the screen cover of the ignition hood to burner and ensure the spark probes are directly overtop of a burner port hole. The sparking probes and the thermocouple must be in the path of a flame to ignite the gas for proper ignition of the flame. Replace the screen cover and follow the operating instructions.

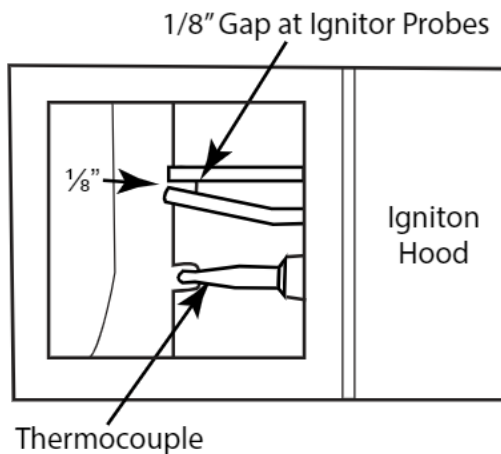

Fig. 24 Proper alignment of probes and thermocouple.

LEARNING THE REMOTE CONTROL TO THE MODULE

The fire pit is unique that it comes standard with one remote controlled transmitter. The handheld remote is shipped with this system are already learned (programmed) to the module inside the control box. Additional transmitters can be learned to this electronic module; up to a total of three transmitters are available. Contact Firegear to discuss additional transmitter options or see the accessory page of this instruction manual.

Learning the new transmitters is simple, but will require pressing the learn button on the module. You should learn any new transmitters before the final installation of the fire pit. Follow the steps below:

1. Remove the two screws securing the cover on the control box (See Fig. 25). The cover will slide down exposing the gas valve and control module.
2. Find the black module attached to the inside of the control box. Locate the "Learn Button" on the bottom of the module.
3. Once the Learn button is located, press and release the button once. You will hear a beep indicating that the module is ready to receive a transmitter code (See Fig. 26)
4. Take the transmitter and press the OFF button. You will hear a series of rapid beeps indicating the module has accepted the new code.

NOTE: A maximum of three (3) codes can be programmed to the module. After a total of three (3) codes have been programmed the memory is full and will not accept any additional codes. To clear all codes, press and hold the learn button for 10 seconds. The module will beep three (3) times indicating the memory is clear of all codes. After codes have been cleared see to Step #3 above to re-learn transmitter.

INSTALLATION OF LAVA ROCK/MEDIA INTO BURNER PAN

Install lava rock/media into the burner pan. Ensure the media is a minimum of 1 to 2-inch diameter for proper operation. **Note:** Do not pour lava rock directly from bag. Media should be placed naturally and NOT packed in tight. Loose fitting is important to ensure robust flames. Be sure rocks are free of any excessive dust. This prevents the burner pan weep holes from being plugged and holding water. **IMPORTANT:** Do not place media over top or under the screen cover. The screen must be free of any debris to ensure proper lighting of burner and to allow proper heating of the thermocouple.

Cover the burner completely with media but do not make the depth greater than 1-inch overtop of the burner portholes.

Decorative glass may be loosely scattered on top of the lava rock. Do NOT cover the stainless steel screen cover with any rock or glass. It must be free an any media/debris to operate properly.

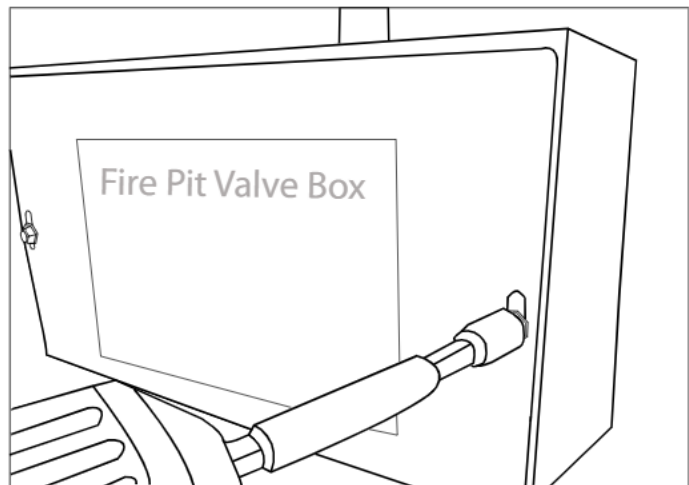

Fig. 25 Removing the cover from metal box.

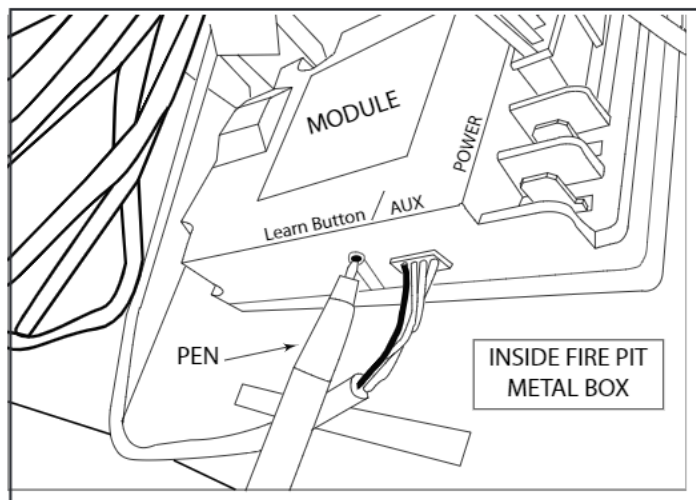

Fig. 26 Learn button location

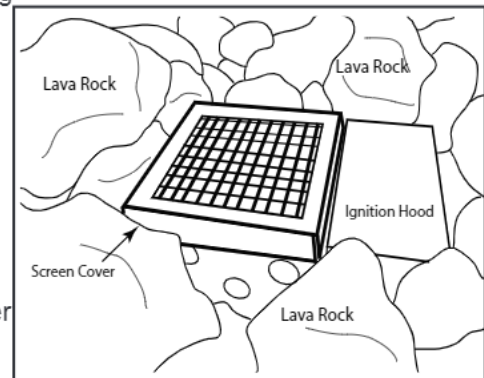

Fig. 27 Keep screen cover exposed

OPERATION

CAUTION: Children and adults should be alerted to the hazards on high surface temperatures and should stay away to avoid burns or clothing ignition. Young children should be carefully supervised when they are in the area of the appliance.

WARNING: Do not use this appliance if any part has been under water. Immediately call a qualified service technician to inspect the appliance and to replace any part of control system and any gas control, which has been under water.

SAFETY WARNINGS

1. Never leave the fire pit unattended during operation.
2. Clothing or other flammable materials should not be placed on or near the appliance.
3. Any guard or other protective device removed for servicing the appliance must be replaced prior to operating the appliance.
4. Installation and repair should be done by a qualified service person. The appliance should be inspected before use and at least annually by a qualified service person. More frequent cleaning may be required as necessary. It is imperative the control compartment, burners and circulating air passageways of the appliance be kept clean.
5. Inspect the fuel supply connection before each use of the appliance.
6. Temporary storage of this appliance indoors is permissible only if it has been disconnected from its fuel supply (Natural or L.P. gas line).

WARNING

1. This appliance is hot when operated and can cause severe burns if contacted.
2. Do not burn any solid fuels in this appliance.

LIGHTING INSTRUCTIONS

READ ALL WARNING AND SAFETY INFORMATION ABOVE BEFORE ATTEMPTING TO LIGHT FIRE PIT

TURNING ON FIRE PIT

1. Ensure you have leak tested the fire pit before operating. Turn main gas supply ON.
2. Ensure batteries are installed in battery pack and switch is on Latching Solenoid.
3. Press the **ON** button on the transmitter (Fig. 28) You will hear the ignitor probe begin sparking for 15-seconds and the fire pit will turn ON.
4. If the fire pit does not light the module will “beep” one time every second indicating an ignition error. This is a hard lockout. If this occurs press the **OFF** button on the remote control and repeat step 1-3.
5. If fire pit does not light after second try turn main gas OFF, wait 5 minutes and repeat steps 1-3.

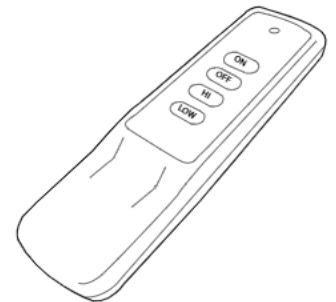

Fig. 28 Transmitter

NOTE: It may take several cycles of ON/OFF to purge the airflow from the gas lines. The direct spark ignition will turn OFF after 15 seconds if the burner does not light after which you will need to press transmitter OFF button then back ON to initiate ignition again.

Flame height is HI and LO. By pressing the buttons on the handheld transmitter you can operate ON-OFF-HI-LO. The transmitter defaults to the HI setting when initially lighting the fire pit each time but will remember the last setting used and change back to that last setting in approximately 5 seconds after lighting.

TURNING OFF FIRE PIT

1. To turn OFF the fire pit press the OFF button on the transmitter. Fire pit will turn OFF.
2. After fire pit has completely cooled off install cover.

TROUBLE SHOOTING FOR TFS MODELS

FAULT CODES

The VCS-5000MODTC control module has built-in error detection for several common operating fault conditions. When the control module detects an error, it will emit a series of beeps. The beeping pattern will help to determine the cause of the operating fault.

Ignition Safety (Protection for ignition system):

Error Code: One beep every one second.

Description of Fault: Warn users if the pilot is not successfully ignited in 15 seconds.

How to Clear: Press OFF then ON buttons to re-attempt ignition.

What to Check:

1. Ensure gas supply is turned on.
2. Ensure that the gas line is purged of air. Air is common in the gas line if the appliance has just been installed, has been disconnected then re-connected to the gas line, or if the appliance has been unused for an extended period of time.
3. Ensure there is no blockage in the gas line.
4. Make sure that the flame sensor electrode is clean. Soot buildup will insulate the electrode and will not allow for proper flame sensing.
5. Ensure orange/white leads from module are plugged into the "PILOT" connection on the valve body.
6. Ensure green/white leads from module are plugged into the "MAIN" connection on the valve body.
7. Verify lead from igniter on electrode assembly is connected to the "I" terminal on the module.
8. Verify lead from flame sensor on electrode assembly is connected to the "S" terminal on the module.
9. Verify that the black ground lead from the module is connected to a proper ground on the appliance.

Sensor Safety (Protection for flame sensor):

Error Code: 4 Beeps every one second (Constant beeping)

Description of Fault: Warn users the flame sensor detects a flame already present when ignition sequence is initiated. This fault will also occur if the flame sensor is shorted to ground.

How to Clear: Press OFF then ON buttons to re-attempt normal ignition.

What to Check:

1. Check if flame is actually present when valve is turned OFF (if so, replace valve).
2. Ensure that the flame sensor electrode is not touching the burner or another metal surface.
3. Check to ensure ground wire from thermocouple and module is connected to gas valve.
4. If 3-probe ignitor is exposed to excessive moisture/water it will need 24-48 hours to dry out.
6. Replace electrode assembly.
7. Replace module.

Thermal Safety (Overheat Protection):

Error Code: 4 Beeps every 2 seconds.

Description of Fault: Warn users that the modules internal temperature exceeds 170°F.

How to Clear: Module's internal temperature must cool to below 160°F and then press ON button.

What to Check:

1. Ensure that there is proper ventilation to the control module.
2. Is module located in unapproved location, too close to burner?
3. Move to cooler location.

Wireless Remote Transmitter Will Not Operate Appliance

1. Make sure that the transmitter is within the 25-foot operational range of the control module.
2. Ensure batteries in transmitter are fully charged and properly installed.
3. If using the battery pack, ensure batteries are fully charged and properly installed. Also, make sure the battery pack's 4-pin connector is securely connected to the battery pack and control module.
4. If using optional AC adapter, ensure that the AC adapter leads are securely attached to "POWER" connection on the control module. Also, ensure that the AC adapter is connected to a live 120VAC power source.
5. Ensure "Remote/Off" switch on control module is set to "Remote".
6. Ensure the control module has learned the transmitter's security code (learning section page 23).
7. Make sure that the remote transmitter is not placed/mounted to a metal surface, which will reduce the operating range.
8. Make sure that there is not a large metal obstruction between the remote transmitter and the control module.

Igniter Electrode Sparks Frequently During Operation

1. The control module will generate a spark at the igniter electrode if the system is in the ON position, but does not sense a flame.
2. Make sure that the flame sensor electrode is clean. Soot buildup will insulate the electrode and will not allow for proper flame sensing.
3. Make sure that wind does not blow the flame off of the flame sensor. The sensor hood and the appliance media (rocks, glass, etc.) provides shielding from the wind. Ensure that the sensor hood and appliance media is properly positioned per the appliance instructions. If wind is too strong, and the flame will not maintain contact with the flame sensor, the appliance should not be operated.

Flame Modulation Will Not Work or Works Backwards

1. Ensure that the black and red leads from the battery pack are securely connected to the red and black leads from the Hi/Lo latching solenoid located on the valve body (red to red and black to black).
2. Verify that the selector switch on the battery pack is set to LATCHING SOLENOID only.
3. Check functionality with all transmitters to determine if there is an issue with the main control system or an individual transmitter. If the issue is with an individual transmitter, make sure that the batteries in both the transmitter and battery pack are installed properly and fully charged.

Fig. 29 Wiring Diagram

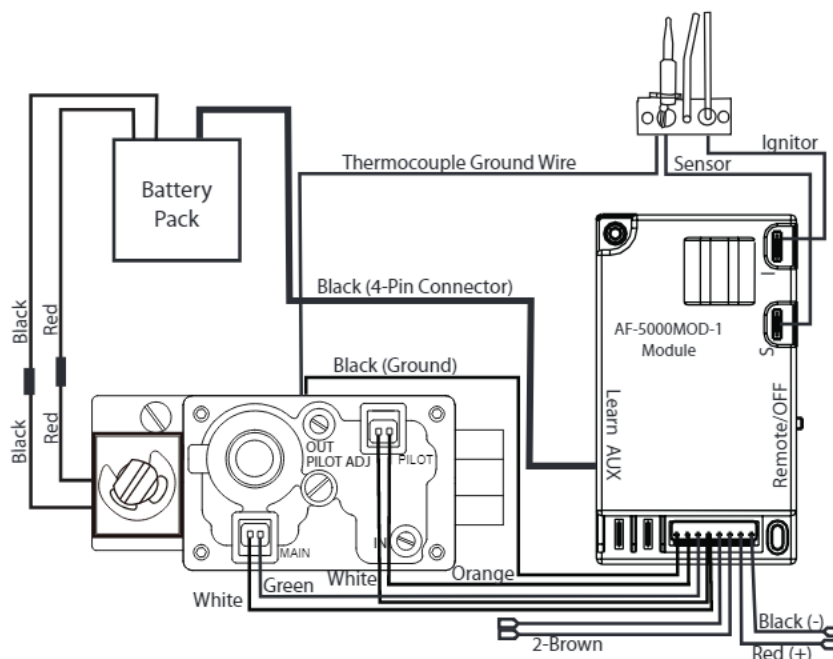

ADDITIONAL TROUBLE SHOOTING

Symptom	Remedy
Fire Pit Won't Light	<ol style="list-style-type: none"> 1. Bleed gas line. 2. Ensure all gas lines are turned ON. 3. Ensure there is not too much media overtop the burner, it can inhibit the gas flow. Too little or no media can also contribute to non-lighting. 4. Check alignment of thermocouple (TC) over rainshield on page 22, Fig. 23. Adjust if needed. 5. Check batteries in battery pack. Minimum total voltage to operate should be 5.3 volts.
No Spark to Ignite	<ol style="list-style-type: none"> 1. Visually look at ignitor for any physical damage. 2. Ensure batteries are not installed backwards in battery pack. Check min. voltage of 5.3 volts. 3. Ensure battery in transmitter is not installed backwards and at minimum voltage of 9.0 DCV.
Continues to Spark after Lighting	<ol style="list-style-type: none"> 1. Thermocouple out of alignment. 2. Check connection of thermocouple at "S" terminal on control module to ensure it is connected.
Low Flame	<ol style="list-style-type: none"> 1. Ensure the base media is at least 1 to 2-inch in diameter and top media is no more than 1-inch over top of burner. 2. Ensure all shut-off valves and valve is fully open. 3. Check for spider webs inside burner orifice.
Water in my Fire Pit	<ol style="list-style-type: none"> 1. Excess dust/sand material from media may be blocking the weep holes to relieve water. Remove all media and unplug weep holes. Clean or install new media free of dust and dirt. 2. Ensure fire pit enclosure has proper drainage for water and proper ventilation to dry out. 3. Recommend to purchase a cover/lid to keep excessive water out of the fire pit.
Whistling Noises	<ol style="list-style-type: none"> 1. Check media to ensure it is not too tightly packed around the burner tube. 2. Ensure a non-whistling flex connector is being used.
Fire Pit Won't Stay Lit	<ol style="list-style-type: none"> 1. Check alignment of thermocouple over rainshield on page 22, Fig. 23. 2. Thermocouple reading should be between 10-20mV. Test at the brass ground lead on gas valve and the gold lead at "S" terminal on the control module. If no minimum millivolts are maintained replace the TC. 3. Check continuity of thermocouple. Using a volt meter remove the TC test lead "S" from the control module and the brass fork terminal from the gas valve. Test for continuity. If no continuity then replace the TC. 4. Ensure thermocouple is clean and free of any debris. Excessive soot can be an issue.

FIRE PIT MAINTENANCE

1. The fire pit should be inspected and cleaned before initial use at least annually by a qualified field service person.
2. Any component that is found faulty must be replaced with an approved component.
3. Any tampering or modifying with the fire pit is dangerous and voids all warranties.
4. During winter months in cold climates and various seasons operation the fire pit may be affected by weather conditions. It is recommended to use a ventilated cover overtop of your fire pit to protect it from humid/rainy weather conditions when not in use. Heavy rains/downpours could affect the fire pit operation if not covered; if this occurs ensure you allow the fire pit time to dry out before attempting to operate. **NOTE:** If a combustible type cover is used over the fire pit when not in use be sure to remove it before operation to prevent a severe safety hazard.
5. Carbon (soot) may build up on the surface of logs (if installed) during heavy use. Sooting may also occur periodically on the screen of the ignitor hood. To clean, brush off with a dry bristle brush or cloth. Keep soot away from clothing or furniture.
6. Over time stainless steel parts can discolor when heated, usually a golden or brown hue. This discoloration is normal and does not affect the performance of the appliance.

Expanded View of Thermocouple Flame Sense (TFS) Fire Pits

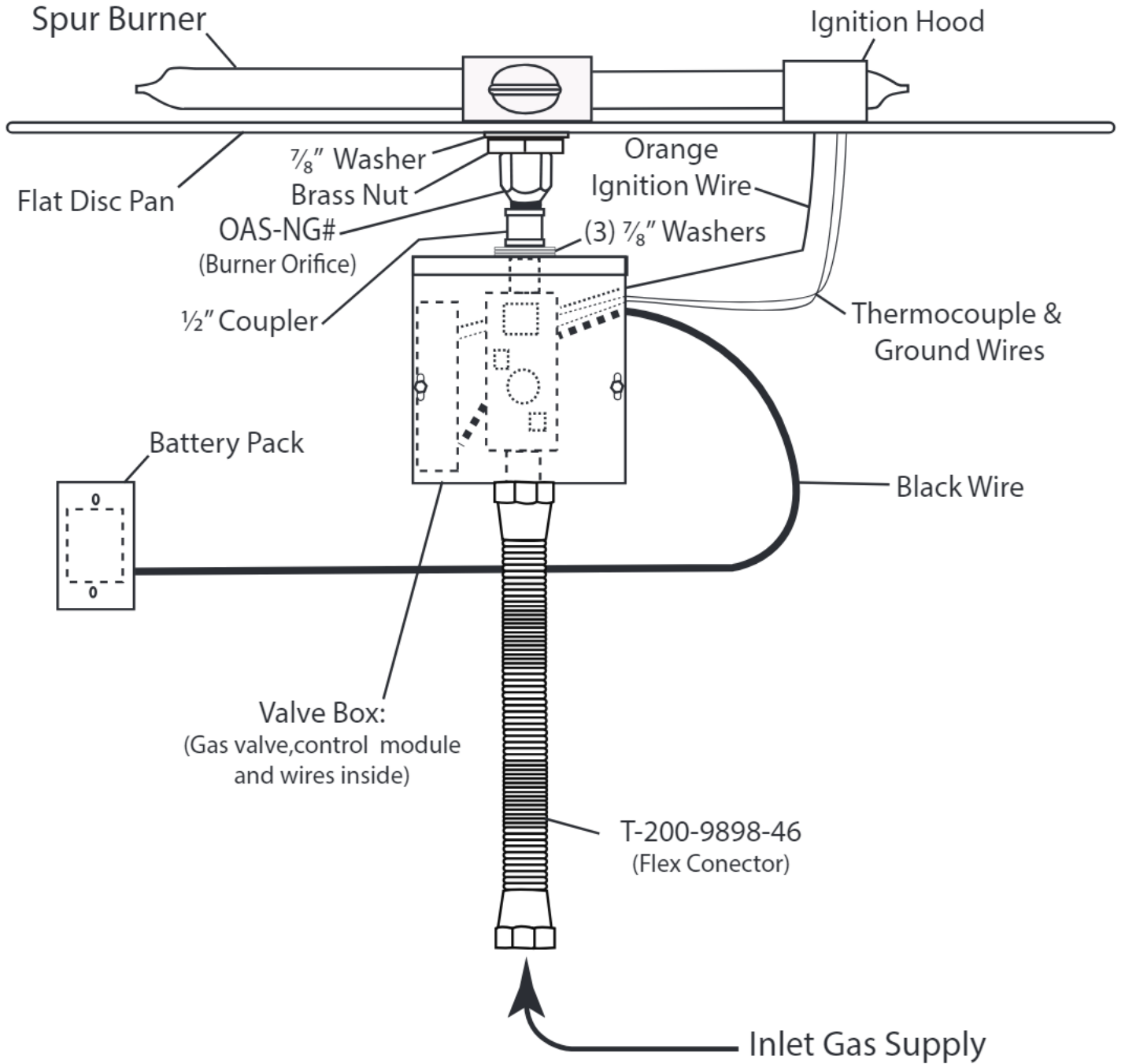

Note: Use joint compound or Teflon tape resistant to all gasses on all male NPT threads; not flared fittings. Ensure all connections are tight and check for gas leaks before and after assembly is complete.

Replacement Parts

Accessories



ROUND FLAT DISC REPLACEMENT PARTS

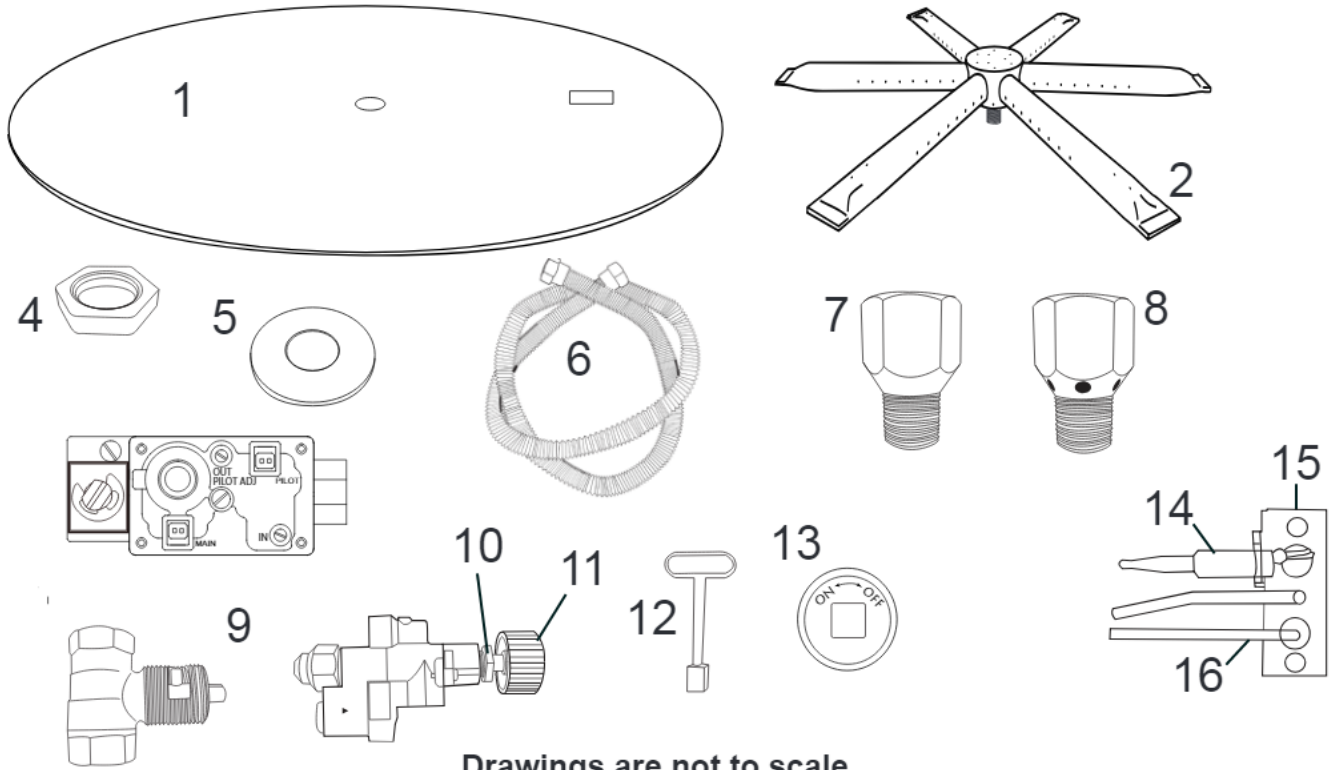

Drawings are not to scale

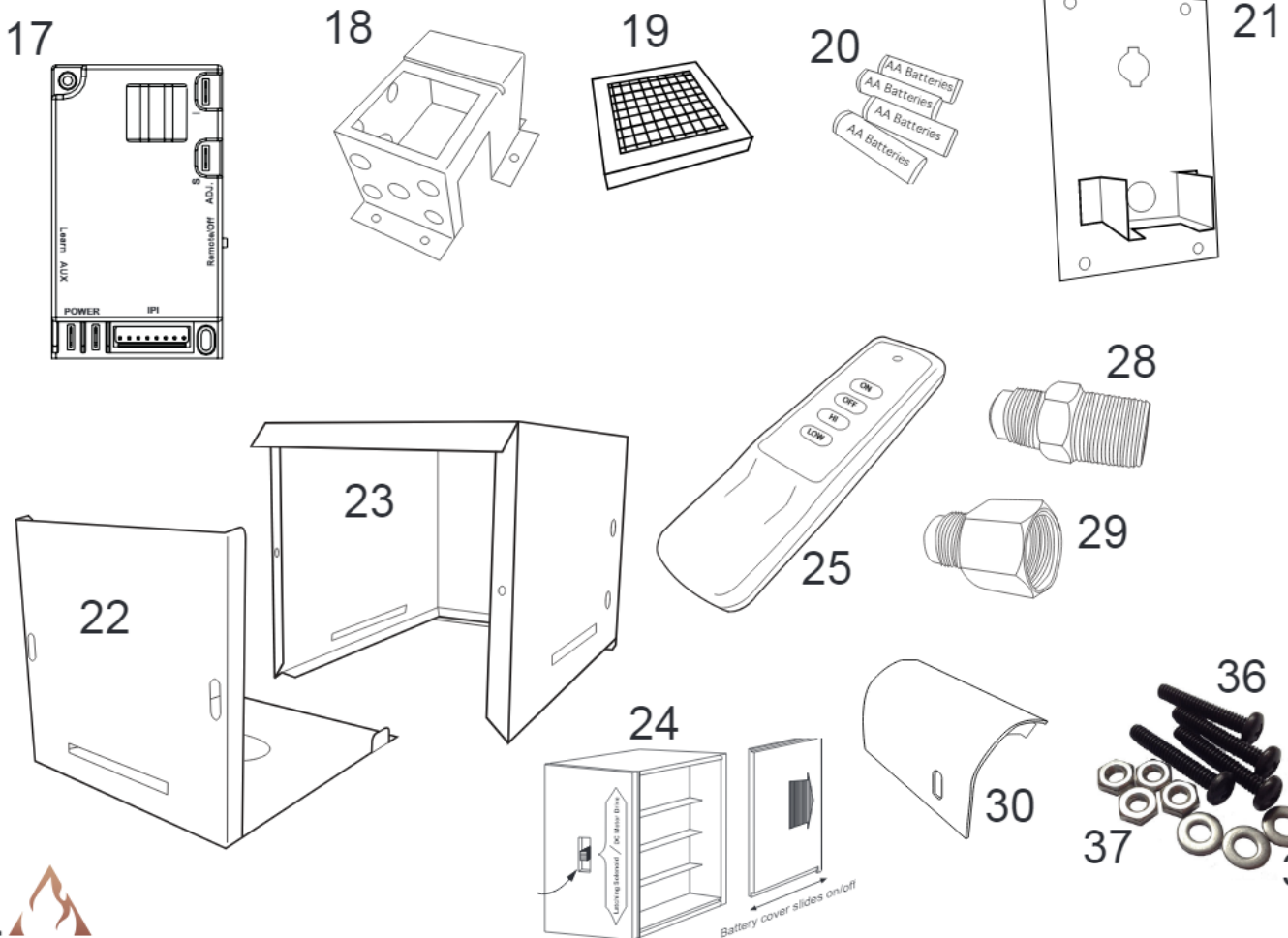

ROUND FLAT DISC REPLACEMENT PARTS LIST

Item	Description	Qty.	Part Number	MT	TMSI	TFS
1	19¼-inch Round Flat Stainless Disc (FPB-20DBS)	1	PAN-SS19.75D	x	x	x
1	26-inch Round Flat Stainless Disc	1	PAN-SS26D	x	x	x
1	29-inch Round Flat Stainless Disc	1	PAN-SS29D	x	x	x
1	34-inch Round Flat Stainless Disc	1	PAN-SS34D	x	x	x
1	44-inch Round Flat Stainless Disc	1	PAN-SS44D	x	x	
2	16-inch Burning Spur (used on FPB-20DBS fire pits only)	1	B-SPUR-16	x	x	x
2	22-inch Burning Spur (used on all flat pans except FPB-20DBS)	1	B-SPUR-22	x	x	x
3	Red Silicone "O" Ring (not shown)	1	ORING			x
4	½" NPS Brass Mounting Nut	1	105-8	x	x	x
5	7/8" Flat Washer/Spacer	1	ST3-113-1026	x	x	x
6	1/2" Flex Gas Line (46-inch Length)	1	T-200-9898-46	x	x	x
7	Orifice Air Shutter NG (Used on MT & TMSI Natural models)	1	OAS-NG29	x	x	x
8	Orifice Air Shutter LP (Used on MT & TMSI Propane models)	1	OAS-LP41	x	x	x
8	Orifice Air Shutter NG (Used on TFS Natural models)	1	OAS-NG7			x
8	Orifice Air Shutter LP (Used on TFS Propane models)	1	OAS-LP31			x
9	Electronic IPI Gas Valve with Solenoid	1	AF-4026			x
9	Key Valve	1	BVL25	x		
9	Manual Gas Valve (TMSI)	1	ST3-080-1009		x	
10	Gas Valve Mounting Nut (used with TMSI valve)	1	ST3-110-1005		x	
11	Manual Gas Valve Control Knob	1	ST3-050-1024		x	
12	Chrome Plated Key	1	KEY-PC-12	x		
13	Chrome Cover Plate	1	CVR-BVL2CP	x		
14	Thermocouple for TFS Pilot (Must be ordered with item #15)	1	ST3-040-1023			x
14	Thermocouple for TMSI Pilot	1	ST3-040-1025		x	
15	Thermocouple Bracket (Must be ordered with TFS item #14)	1	ST3-100-1054			x
16	Ignitor Probes	1	VCS-5000DSI2P01			x
17	Ignition Module	1	VCS-5000MODTC			x
18	Ignition Hood for Spur Burner	1	SPURHOOD		x	x
19	Mesh Screen Cover	1	ST3-100-1027		x	x
20	AA Batteries 1.5 Volt (used in battery pack)	4	BATTAA			x
21	Valve Mounting Plate (used with item #9)	1	TMSIFACEPLATE		x	
22	Valve Box Stainless Steel Lid	1	ST3-100-1033			x
23	Valve Box Stainless Steel		ST3-100-1034			x
24	Battery Pack (with 12-foot 4-Pin, 4-wire harness, cover plate and 12-foot red & black 2-wire harness for solenoid)	1	AF-4000BP12			x
25	ON/OFF HI/LO Transmitter	1	RCAF-3TXUNF			x
26	Transmitter Battery (not shown)	1	BATT12VOLT			x
27	Stainless Thread Cutting Screws #10-24x ½" (not shown)	4	ST3-113-1028			x
28	½" NPT to ½" Male Flare Fitting	1	U1-8D-S	x	x	
29	½" NPT Female to Male Flare Fitting	1	U3-8D-S	x	x	
30	Rain Shield	1	RAINSHIELD		x	x
31	1/2" Stainless Steel Coupler (not shown)	1	SS499-8			x
32	Gas Valve 8-Pin Wiring Harness (not shown)	1	AF-40008PIN12WH/2			x
33	Weatherproof Junction Box with Tabs (not shown)	1	WP-JBOX			x
34	12-inch, 8-Pin Wire Harness (not shown)	1	ST3-042-1001			x
35	½" NPT Male to Male Close Nipple (not shown)	1	ST3-093-1025			x

ROUND FLAT DISC REPLACEMENT PARTS LIST

Item	Description	Qty.	Part Number	MT	TMSI	TFS
36	#10-24 x 1.25" Black Oxide Phillips Screw	4	SCREW1024PANBL			
37	#10-24 Stainless Nut	4	ST3-113-1020		x	
38	#10 Stainless Flat Washer	4	WASHER10SS		x	
30	Thermocouple/Ignitor/Rainshield Replacement Kit (not shown)	1	TFS-IGNT-ASSEMBLY			x
40	Thermocouple/Rainshield Replacement Kit (not shown)	1	TMS-TC-ASSEMBLY		x	
41	Manual Spark Ignitor Module (not shown)	1	3042-RB		x	
42	23" Piezo Extension wire - See page 16 (not shown)	1	PIEZO23WH		x	
43	48" Piezo Extension wire - See page 16 (not shown)	1	PIEZO48WH		x	
44	Ground tab for Piezo ignition (not shown)	1	GROUNDTAB		x	
45	Weatherproof Cover/lid (not shown)	1	WP-COVER			x
46	6-32 x 1" Flat Head Phillips Screw - Holds WP Lid to WP-JBOX (not shown)	4	SCREW6-32X1PHFHZ			x

FOR TECHNICAL SERVICE, CALL: (855) 498-8324





Firegear Outdoors
 9230 Conservation Way
 Fort Wayne, IN 46809
 Sales: (888) 672-8929
 Sales Support: (888) 699-6167
 Canadian Inquires: (877) 472-3923

Web Site: www.firegearoutdoors.com

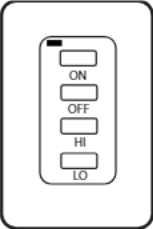

OPTIONAL ACCESSORIES

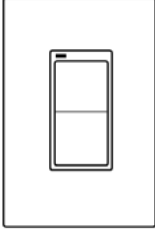
The following accessories are available from your local Firegear dealer/distributor.
Each accessory comes with a separate installation manual. Read each instruction thoroughly before installing.

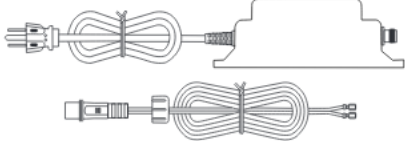
<p><i>Media</i> Lava Stones: 1" to 2" size (50 lbs) Model: FG-LS-50</p>	<p><i>Media</i> Lava Boulders: 6" to 12" size (30lbs) Model: FG-LB30</p>	<p><i>Media</i> Lava Rock: 1" to 1½" size (50 lbs) Model: FG-LAVA-50</p>				
<p><i>Wireless Wall Switch</i></p>  <p>ON/OFF/HI/LO (TFS models only) Model: 1322-WT</p>	<p><i>Wireless 4-button Timer</i></p>  <p>30/60/120/OFF (TFS models only) Model: TMR-AF1</p>	<p><i>Wireless Wall Switch</i></p>  <p>ON/OFF (TFS models only) Model: 1001D-AF1-TX</p>				
<p><i>LP Conversion Kit</i> For use with listed models below. Kit Includes: OAS, rating plate sticker and instructions. Model: LPK#41</p> <p>For Use With Models:</p> <ul style="list-style-type: none"> FPB-20DBSMT-N FPB-34DBSMT-N FPB-34DBSTMSI-N FPB-44DBSMT-N FPB-44DBSTMSI-N  <p>NOTE: There is no LP conversion kit for Thermocouple Flame Sense (TFS) models. You must order any Propane models directly from the factory.</p>	<p><i>Shut-Off Valves</i></p> <p>Model: 01-387 ¾" OD Flare x ½" FIP Model: 01-487 ½" OD Flare x ½" FIP Model: 01-266 ¾" OD Flare x ¾" OD Flare Model: 01-288 ½" OD Flare x ½" OD Flare</p> <p>Model: ADP10-OUT (10' wire); ADP70-OUT (70' wire)</p>  <p>Outdoor approved 7.5VDC adapter/transformer eliminates the use of battery power with any TFS system.</p>	<p><i>Home Automation System</i> A transmitter compatible with home automation systems using dry contacts to operate fire pit. Model: AF4000HAT</p> <p><i>Vent Kits</i> Provide 18 sq. in. of ventilation per side of enclosure)</p> <p>Model: VENT-KIT-6X12SS Model: PAVER-VENT-4LNLS Model: PAVER-VENT-6LNLS</p> <p><i>Paver Control Panels</i></p> <table style="width: 100%; border: none;"> <tr> <td>PAVER-CP-MT</td> <td>MT systems</td> </tr> <tr> <td>PAVER-CP-TMSI</td> <td>TMSI systems</td> </tr> </table>	PAVER-CP-MT	MT systems	PAVER-CP-TMSI	TMSI systems
PAVER-CP-MT	MT systems					
PAVER-CP-TMSI	TMSI systems					
<p><i>Log Sets</i></p> <p>Model: L-SF (Spit Fire) - 17pc (52lbs) L-BF (Beach Fire) 8pc (20lbs) L-Sedona (Sedona) 19pc (200lbs) 326-930 Twigs 6pc (20lbs)</p>	<p><i>E-STOP</i></p> <p>Mechanical gas timer valve with emergency shut-off.</p> <p>Model: ESTOP1-0H 1hr. timer Model: ESTOP2-5H 2.5hr. timer * Not for use with TFS fire pit systems</p>	<p><i>FLEXFRAME</i></p> <p>Universal brackets to support fire pit disc when using paver blocks or other non-combustible enclosures.</p> <p>Model: FLEXFRAME-SS</p>				

NOTE: See the Firegear Outdoors catalogue for a variety of fittings and flex connectors and other glass media.



LIMITED WARRANTY

Skytech Products Group (Firegear Outdoors) hereby warrants to the end user that products will be free from material and workmanship defects that prevent safe and correct operation of the product. The warranty commences from date of sale to the end user for the following period:

CONSUMER/NON-COMMERCIAL APPLICATIONS:

Stainless Steel Components	5 Years
Gas Valve, Spark Igniter & Electronic Parts	2 Years
Log Sets	3 Years
Glass Windshields	5 Years
Glass Media	1 Year
Controls	5 Years
AnF Enclosures	5 Years
GFRC (Glass Fiber Reinforced Concrete)	1 Year

Lava Rock and Lava Stones are not covered by warranty

COMMERCIAL APPLICATIONS:

Stainless Steel Components	1 Year
Gas Valve, Spark Igniter & Electronic Parts	1 Year
Log Sets	1 Year
Glass Windshields	1 Year
Glass Media	1 Year
Controls	1 Year
AnF Enclosures	1 Year
GFRC (Glass Fiber Reinforced Concrete)	1 Year

Lava Rock and Lava Stones are not covered by warranty

End User must provide a bill of sale, canceled check, or payment record from the end user to verify purchase date and to establish warranty period. This Limited Warranty shall be valid and limited to the original purchaser only.

WARNING Any modification to the product will void the warranty.

This Limited Warranty shall be limited to the repair and/or replacement of parts that have proven to be defective under normal use and service. Before returning any parts, contact our Technical Service Department for a Return Materials Authorization (RMA) number. All warranty claims must be made by the OEM / Distributor / Dealer account on behalf of the end user. You may contact Technical Service at (855) 498-8324.

All approved returned defects must be confirmed by our Technical Service Department. If the defect is confirmed and we approve the claim, we will replace such parts without charge. This warranty gives you specific legal rights, and you may also have other rights, which vary from state to state.

Travel, diagnostic cost, service labor to repair the defect and freight charges on warranty parts to and from the factory will be responsibility of the owner. We will not be responsible for labor charges and/or damage incurred in installation, repair, and replacement.

This Limited Warranty is voided if not assembled, installed and operated as intended. This Limited Warranty does not cover any defects due to accident, abuse, misuse, alteration, misapplication, vandalism, improper installation or improper maintenance or service, removal from the original location or re- installation into another location, or failure to perform normal and routine maintenance.

Damage due to severe weather conditions such as hail, hurricanes, earthquakes, tornadoes, discoloration due to overheating, exposure to chemicals (including salt), either directly or in the atmosphere, or very high humidity, is not covered by this Limited Warranty.

There are no other express warranties except as set forth herein. For consumer applications, any applicable implied warranties of merchantability and fitness are limited in duration to the period of coverage of this Limited Warranty. Some states do not allow limitation on how long an implied warranty lasts, so this limitation may not apply to you.

For Commercial applications, the liability of Firegear Outdoors is limited to the express terms of this warranty. We expressly disclaim any and all implied warranties, including any warranties of fitness for a particular purpose or merchantability.

We are not liable for any special, indirect or consequential damages. Our maximum liability is limited to the purchase price of the purchased products. Some states do not allow the exclusion or limitation of incidental or consequential damages, so this limitation or exclusions may not apply to you.

We do not authorize any person or company to assume for it any other obligation or liability in connection with the sale, installation, use, removal, return, or replacement of its equipment; and no such representations are binding.

REV. 6/18



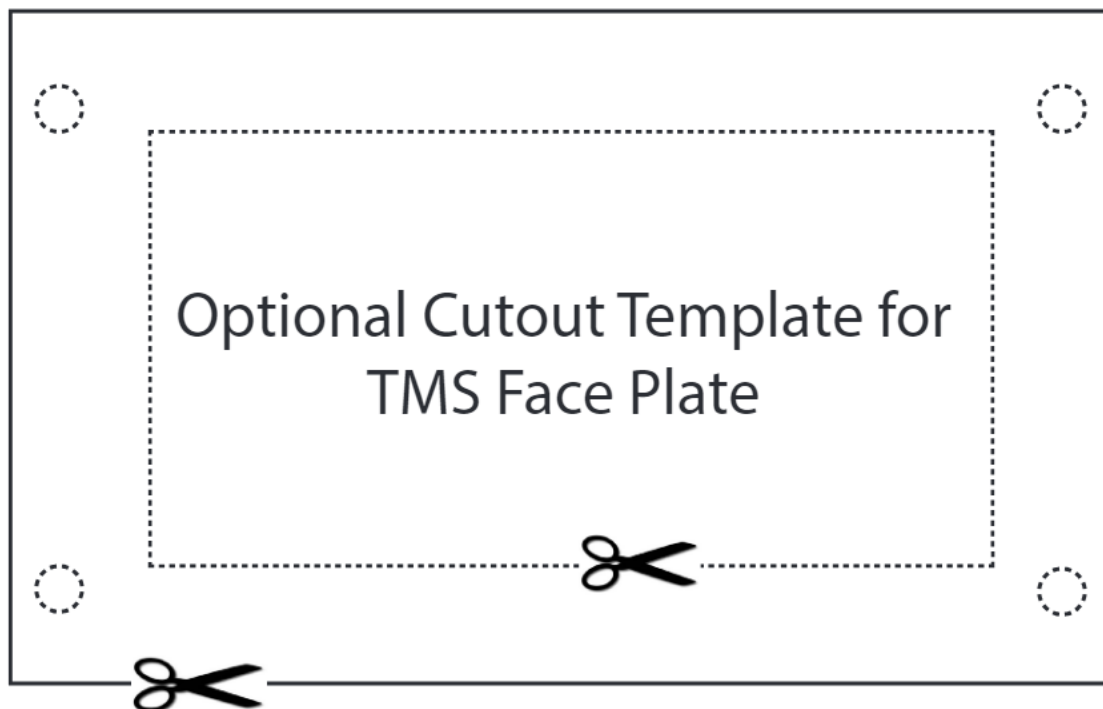

This fire pit instruction provides an option to mount the TMSI face plate to concrete board. Use the template above to complete the installation.

The TMSI face plate can be mounted vertically or horizontally. Our suggestion is to attach the face plate in a horizontal position with the gas valve on the left side. This allows the control knob text to be orientated in a position to be easily read. **Note:** Mounting plate can also be installed into a paver control panel (PAVER-CP-TMSI) bracket system.

Using scissors carefully cutout the template and trace it on your concrete board. The dotted line provides the cutout area to mount face plate. Use a concrete drill bit to drill (4) 3/16" diameter holes. Install the 1¼" screws through the front of the faceplate with the nuts and washers on the backside. These are all provided in the hardware bag.

CAUTION: Careful not to over-tighten screws and nuts to ensure the cement board does not crack or break.



Having problems getting the fire pit to operate? Don't leave the job site!
We want to help! Call 855.498.8324 for Technical Support
between the hours of 8:00AM to 5:00PM EST.
Text photos to 260.255.5750 or e-mail photos to support@skytechpg.com.

BEFORE YOU CALL WE WILL NEED THIS INFORMATION

1. Model Number: _____
2. Serial Number: _____
3. How long is the gas line run? Nat Gas ____ LP Gas ____
4. What size is gas line? _____
5. Inlet Gas Pressure: _____ WC
Manifold Gas Pressure: _____ WC
6. What type of media are you using? _____
7. Review the troubleshooting section in the installation manual.
8. What are the symptoms? Please be prepared to explain.
9. Be prepared to send photos to us when on the phone.
10. Found missing or damaged parts? Let us know ASAP or send photos.